

# PRO

# 469

## Irrigation Controller

### Instruction Manual

- STATION MODELS** – Available in 4, 6 or 9 stations.  
**INDOOR MODEL** – Supplied with 240VAC x 24VAC plug pack.  
**OUTDOOR MODEL** – Supplied with 240VAC x 24VAC inbuilt transformer, lead with plug.



N10372



# CONTENTS

<b>Introduction</b>	1	<b>Field wiring connections</b>	24-25
<b>Glossary</b>	2	<b>Terminal block layout</b>	25
<b>Key Features</b>	3	<b>Pump Start Relay Connection</b>	26
<b>Programming Instructions</b>		<b>Single phase pump installation</b>	26
Introduction	4	<b>Master valve installation</b>	27
Set automatic program	4	(including rain sensor )	
Programming example	5	<b>Power supply connections</b>	27
Spare watering planner	6	<b>Station (valve) installation</b>	28
General tips for easy programming	7	<b>Pump protection (system test)</b>	29
<b>Programming</b>		<b>Fault Finding Guide</b>	30-31
Set current time & correct day	8	<b>Electrical Characteristics</b>	32
Set calendar	8	<b>Electrical outputs</b>	32
Set start times	9	<b>Servicing the controller</b>	33
Set watering days	10-11	<b>Spare watering planner</b>	34-37
Set station run times	11-12	<b>Guarantee</b>	
<b>Manual Operations</b>			
Run a single station	13		
Run a system test	13-14		
Run a program	14-15		
Stop watering	16		
Stacking start times	16		
Automatic back up	16		
<b>Other Features</b>			
Rain sensor	17		
Rain delay	18		
STOP all watering	18		
Water budgeting & seasonal adjustment	19		
<b>Special Functions</b>			
Pump ON/OFF selection	20-21		
Pressure build	21-22		
Water hammer saver	22-23		
<b>Installation Instructions</b>			
Mounting the controller	24		
Electrical hook-up	24		

# INTRODUCTION

**PRO469** is available in 4, 6 and 9 station configurations. Designed to cover a wide range of applications from residential and commercial turf, to light agriculture, and professional nursery.

This controller has a possible 6 separate programs with up to 36 starts per day. The controller has a 7 day watering schedule with individual day selection per program or a 365 calendar for odd/even day watering or selectable interval watering schedules from every day to every 15th day. Individual stations can be allocated to one or all programs and can have a run time of 1 minute to 12 hours 59 minutes or 25 hours if the water budget is set to 200%.

Holman has always been concerned with sustainable water usage. The controller has many water saving features that can be used to maintain the highest standard of plant quality with the least amount of water consumption. The integrated budget facility allows global changes of run times without affecting programmed run times. This allows for decreasing total water consumption on days of minimal evaporation.

# GLOSSARY

## LARGE HIGH CONTRAST LCD

Displays all programming information.

## LARGE SELECTION DIAL

Navigates through all programming information.

## LARGE MENU BUTTONS

Easy operation with fast scroll feature for entry and review.

## QUICK PROGRAM SELECTION KEY

The "P" key allows faster program entry and review.

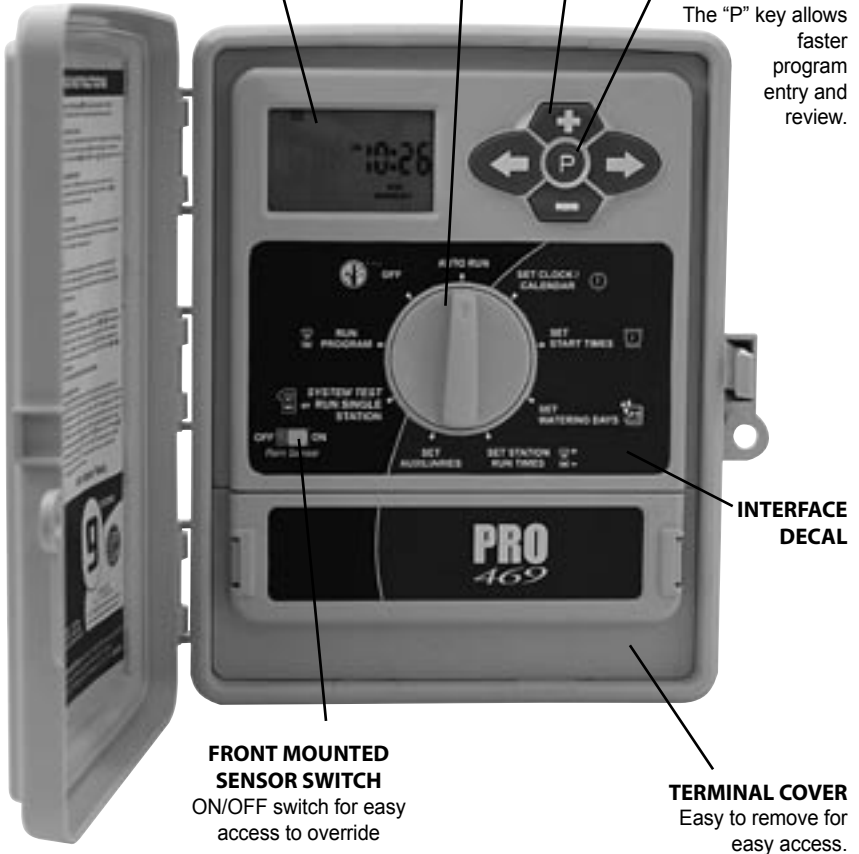

## INTERFACE DECAL

## FRONT MOUNTED SENSOR SWITCH

ON/OFF switch for easy access to override

## TERMINAL COVER

Easy to remove for easy access.

# KEY FEATURES

- 4,6 & 9 station models.
- Two configurations:
  - Indoor model with external transformer. (plug pack)
  - Outdoor model with an inbuilt transformer includes lead & plug.
- 6 programs, each of which has 6 start times. Maximum of 36 start times per day.
- Station run times from 1 minute to 12 hours & 59 minutes.
- Selectable watering options:
  - Individual 7 day selection.
  - Odd or Even day selection.
  - Interval watering day selection from every day to every 15th day.
- Watering budgeting feature allows quick adjustment of the station run times by percentage, from 10% to 200%.
- Rain sensor input will turn off all stations or selected stations during wet periods, if a sensor is installed.
- Permanent memory feature will retain automatic programs during power failures.
- Standard 9 volt block alkaline battery can be used to program the controller remotely and to maintain the clock.
- Manual functions:
  - Run a program or group of programs once.
  - Run a single station.
  - Run a test cycle for all stations.
  - "OFF" position, stops a watering cycle or to stop automatic programs during winter.
- Pump or master valve input is standard.
- Pump or master valve input can be turned off by program or by individual stations, for dual water supply situations or if stations are used to turn on garden lights.

# PROGRAMMING INSTRUCTIONS

## INTRODUCTION

This controller has been designed with 6 separate programs to allow different landscape areas to have their own individual watering schedules.

A program is a method of grouping stations (valves) with similar watering requirements to water on the same days. These stations will water in sequential order and on the days selected.

- **Group the stations** (valves) which are watering similar landscape areas together. *Examples: Turf, flower beds, gardens. These different groups may require individual watering schedules, or programs*
- **Plan your watering schedule** completing the planner supplied at the back of this book.
- **Set the current time and correct day** of the week. If odd or even day watering is going to be used, make sure the current year, month and day of the month is correct.

***HINT:** To select a different program use the button marked **P**. Each press will move to the next program number. This is handy for quick reviewing of previously entered information without losing your place in the programming cycle.*

## SET AUTOMATIC PROGRAM

- Set the automatic program for each group of stations (valves) by completing the following three steps:

### 1. Set start times

This sets the time when the watering schedule is to commence.

***Note:** For each start time, all the stations (valves) selected for the program will come on in sequential order. If two start times are set, the stations (valves) will come on twice.*

### 2. Set Watering Days

These are the selected days when the automatic system will be active.

### 3. Set Station Run Times

This sets the watering duration required for each station (valve).





















# PROGRAMMING INSTRUCTIONS

## PROGRAMMING EXAMPLE

A typical example of a 9 station system is outlined below as a guide to assist you when planning your watering schedule. In this example only 4 of the possible 6 programs are used, the lawn areas are using gear drive sprinklers. The vegetable garden is using drip and the flower beds are being watered with micro sprays.

VALVE NUMBER			PROGRAM						
1	Front lawn		5	Back lawn					
2	Front lawn		6	Back lawn					
3	Front lawn		7	Flower bed					
4	Flower bed		8	Pots in pergola					
			9	Vegetables					
PROGRAM									
	START TIME	WATERING INTERVAL	STATION	RUN TIME (minutes)	START TIME	WATERING INTERVAL	STATION	RUN TIME (minutes)	
1	Start Time 1: <b>6:00am</b>	<b>MONDAY FRIDAY</b>	1	20	4	Start Time 1: <b>4:00am</b>	<b>TUESDAY SATURDAY</b>	1	
	Start Time 2:		2	20		2			
	Start Time 3:		3	20		3			
	Start Time 4:		4			4			
	Start Time 5:		5	20		5			
	Start Time 6:		6	20		6			
			7			7			
			8			8			
			9			9		45	
2	Start Time 1: <b>8:00pm</b>	<b>WEDNESDAY SUNDAY</b>	1		5	Start Time 1:		1	
	Start Time 2:		2			2			
	Start Time 3:		3			3			
	Start Time 4:		4	10		4			
	Start Time 5:		5			5			
	Start Time 6:		6			6			
			7	10		7			
			8			8			
			9			9			
3	Start Time 1: <b>5:00am</b>	<b>Every second day</b>	1		6	Start Time 1:		1	
	Start Time 2: <b>10pm</b>		2			2			
	Start Time 3:		3			3			
	Start Time 4:		4			4			
	Start Time 5:		5			5			
	Start Time 6:		6			6			
			7			7			
			8	5		8			
			9			9			





# SPARE WATERING PLANNER

VALVE NUMBER		PROGRAM		PROGRAM	
1	5				
2	6				
3	7				
4	8				
	9				
PROGRAM		PROGRAM		PROGRAM	
START TIME	WATERING INTERVAL	START TIME	WATERING INTERVAL	START TIME	WATERING INTERVAL
<b>Start Time 1:</b>		<b>Start Time 1:</b>		<b>Start Time 1:</b>	
Start Time 2:		Start Time 2:		Start Time 2:	
Start Time 3:		Start Time 3:		Start Time 3:	
Start Time 4:		Start Time 4:		Start Time 4:	
Start Time 5:		Start Time 5:		Start Time 5:	
Start Time 6:		Start Time 6:		Start Time 6:	
<b>Start Time 1:</b>		<b>Start Time 1:</b>		<b>Start Time 1:</b>	
Start Time 2:		Start Time 2:		Start Time 2:	
Start Time 3:		Start Time 3:		Start Time 3:	
Start Time 4:		Start Time 4:		Start Time 4:	
Start Time 5:		Start Time 5:		Start Time 5:	
Start Time 6:		Start Time 6:		Start Time 6:	
<b>Start Time 1:</b>		<b>Start Time 1:</b>		<b>Start Time 1:</b>	
Start Time 2:		Start Time 2:		Start Time 2:	
Start Time 3:		Start Time 3:		Start Time 3:	
Start Time 4:		Start Time 4:		Start Time 4:	
Start Time 5:		Start Time 5:		Start Time 5:	
Start Time 6:		Start Time 6:		Start Time 6:	
<b>1</b>	<b>4</b>	<b>4</b>	<b>4</b>	<b>4</b>	<b>4</b>
<b>2</b>	<b>5</b>	<b>5</b>	<b>5</b>	<b>5</b>	<b>5</b>
<b>3</b>	<b>6</b>	<b>6</b>	<b>6</b>	<b>6</b>	<b>6</b>
STATION	STATION	STATION	STATION	STATION	STATION
1	1	1	1	1	1
2	2	2	2	2	2
3	3	3	3	3	3
4	4	4	4	4	4
5	5	5	5	5	5
6	6	6	6	6	6
7	7	7	7	7	7
8	8	8	8	8	8
9	9	9	9	9	9
1	1	1	1	1	1
2	2	2	2	2	2
3	3	3	3	3	3
4	4	4	4	4	4
5	5	5	5	5	5
6	6	6	6	6	6
7	7	7	7	7	7
8	8	8	8	8	8
9	9	9	9	9	9
1	1	1	1	1	1
2	2	2	2	2	2
3	3	3	3	3	3
4	4	4	4	4	4
5	5	5	5	5	5
6	6	6	6	6	6
7	7	7	7	7	7
8	8	8	8	8	8
9	9	9	9	9	9
1	1	1	1	1	1
2	2	2	2	2	2
3	3	3	3	3	3
4	4	4	4	4	4
5	5	5	5	5	5
6	6	6	6	6	6
7	7	7	7	7	7
8	8	8	8	8	8
9	9	9	9	9	9
1	1	1	1	1	1
2	2	2	2	2	2
3	3	3	3	3	3
4	4	4	4	4	4
5	5	5	5	5	5
6	6	6	6	6	6
7	7	7	7	7	7
8	8	8	8	8	8
9	9	9	9	9	9



# PROGRAMMING



This controller has been designed for quick intuitive programming. Remember these simple tips for hassle free programming.

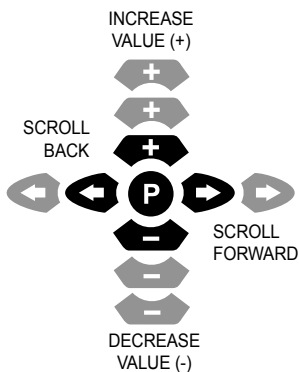

1. Complete the spare watering planner at the back of this book.
2. When setting, one push of the button will increment one unit.
3. Holding one button down will fast scroll through units.
4. During the programming, only flashing units are able to be set.
5. Adjust flashing units using the  or  buttons.
6. Pressing  will scroll forward through the settings in an orderly sequence.
7. Pressing  will scroll back to previous settings and setting can be changed.



The large dial is the primary device for selecting an operation. Rotate the dial to the function you wish to alter or review.



The **P** is used to select different programs. Each push on this button will increment one program number.

Once you have selected the primary function and program you wish to alter, you can then use the  or  to change that function's value.



Only display elements that are flashing can be altered with the   keys.

Use the   to scroll through other values within the function that can be altered.



# PROGRAMMING



## Set current time & correct day

Turn the dial to “Set Clock/Calendar” position.

The hour will be flashing. Use the  or  to adjust.



**NOTE:** AM/PM must be set correctly.

Press  button and the “minutes” will flash. Use  or  to adjust the minutes.

Press  and the “day of the week” will flash. Use  or  to set the correct day.

## Set Calendar

**NOTE:** The calendar only needs to be set when selecting Odd/Even day watering in areas where water restrictions may require this feature.

Press  button until the year, month and day are shown. The “year” will be flashing. Use  or  to adjust if required.

Press  and the “month” will flash. Use  or  to adjust if required.

Press  and the “day” will flash. Use  or  to adjust if required.

**HINT:** To return to the clock, press  and  together or turn dial to another position.

Before proceeding, ensure the spare watering planner has been completed. From your planner, you should be aware which stations (valves) are allocated to each program. Set one program at a time to ensure that the schedules are completed correctly.

# PROGRAMMING

## Example: SET PROGRAM 1

### Step 1 – SET START TIMES

**NOTE:** all stations will come on in sequential order for each start time.

Turn the dial to “Set Start Times” and ensure that “Prog No 1” is showing. If not, then use the **P** button to select “Prog No 1”.

The “Start No” will be flashing. The display will show:

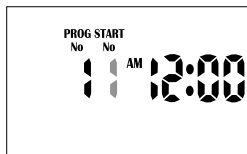

Use **+** or **-** to change the “Start No” if required, otherwise press **▶** and the “hour” will flash. Use **+** or **-** to adjust if required.

**NOTE:** Ensure AM/PM position is correct.

Press **▶** and the “minutes” will flash. Use **+** or **-** to adjust if required.

Each program has up to 6 start times. Should you require a second start time, press **▶** and ‘Start1’ will flash.

Advance to “Start2” by pressing **+**

The display will show:

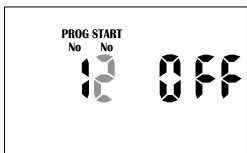

Press **▶** and proceed as per setting Start 1.

**HINT:** To toggle a start on or off press **+** or **-** when the hour is flashing. To change to a different program either to review or alter, press the **P** button. Every press will increment to the next program.

# PROGRAMMING

## Step 2 – SET WATERING DAYS

This unit has interval watering from every day to every 15th day, individual day selection or a 365 day calendar with odd/even day selection in areas where water restrictions require this feature.

### INDIVIDUAL DAY SELECTION

Turn the dial to “Set Watering days” and ensure that “Prog No 1” is showing. If not, then use the **P** button to select “Prog No 1”.

“Monday” will be flashing. The display will show:

*This refers to Mon being Day1.*



To turn Monday off press the **-** button. To turn it back on press the **+** button. To advance to the next day and set it use the **▶** button, the display will then flash Tue and Day 2. Use **+** or **-** to turn days ON or OFF and advance to the next day using **▶**. Remember to set all 7 days ON or OFF.

### ODD/EVEN DAY SELECTION (Optional)

In some regions users are only allowed to water their landscapes on **odd** dates if their house number is **odd**, or **even** dates when their house number is **even**.

This controller allows this to be done simply by setting the relevant selection of odd or even and setting the current date into the controller. The controller will account for leap years.

If you require the odd/even day option, simply press the **▶** button until “Odd” is shown. Press the **▶** button and “Even” will be shown.

This feature may be required in areas where water restrictions are enforced.

**NOTE:** Remember to set the 365 day calendar when setting the clock, or this feature will be out of sequence (refer page 8 “set calendar”).

# PROGRAMMING

## INTERVAL DAY SELECTION

Press the  button until the “interval days” is flashing.

The display will show:

“Interval 1” will be flashing. This means the controller will water every day. The display will show how many days are left before an active schedule.

For example, if it showed “1” then in one day’s time the controller will run this program.

To change the interval day, press the  or  button.

Select from 1 to 15 interval days.

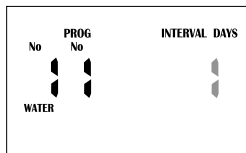

**NOTE:** When changing the interval day, the next active day is always changed to 1. This means that tomorrow is the first active day to run.

## Step 3 – STATION RUN TIMES

This is the length of time that each station (valve) is scheduled to water on a particular program. Maximum watering time is 12 hours 59 minutes for each station.

A station can be assigned to any or all of the possible 6 programs, if required.

Turn the dial to the “Set Station Run Times” position.



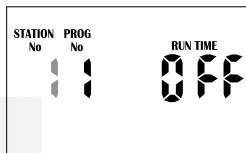

The display will show:









**NOTE:** This means that station 1 of program 1 has no run time programmed in it. The controller has permanent memory so when the device is first used there will be no run times set. Unlike other controllers, when there is a power failure, even if the battery is not installed, the programmed values will be restored to the unit.

# PROGRAMMING



## Step 3 - Station Run Times (cont.)

Press  or  button to select the station (valve) number, and press the  button and the run time minutes will flash. Alter by using  or .



Press the  button and the run time hours will flash. Alter by using  or .

Press the  button and the current station will flash. Select the next station to change by using  or  and proceed by pressing  and alter using  or .

Continue until all the stations in Program1 have been set with a run time or if a station(s) is not required to be active in this particular program, ensure that the run time is set to "OFF".

**NOTE:** To turn a station "OFF" press the  and  at the same time when the station number is flashing or use  to set minutes to 00 when flashing.

This completes the setting up procedure for automatic program 1.

Select from up to 6 programs using the  button for different watering schedules. On every press of the  button the program number will increment. Once on the desired number, follow the three steps to set an automated program:

1. Set start Times
2. Set Watering Days
3. Set Station Run Times

**TIP:** Although the controller will run automatic programs with the main dial in any position (with the exception of "OFF"), it is advisable to leave the main dial in the "AUTO RUN" position when not programming or running manual stations or programs.

# MANUAL OPERATIONS

## Run a Single Station

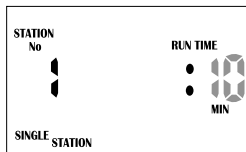

The maximum run time for a station is 12 hours 59 minutes. To manually run a single station once, turn the dial to the “System Test or Run Single Station” position.

The display will show:







The default run time for a single station is 10 minutes.

Advance to the selected station by pressing  as many



times as required, and adjust the run time with  and .

The controller will start running the selected station and the run time will decrement in the display.

If there is an active pump set for this station, the pump icon will flash once the  button has been pressed, indicating that the pump/master is running. As soon as the single station run time has elapsed, the unit will revert back to automatic mode. This means that if you forget to turn the dial back to the “Run” position, the controller will still run its automatic starts, as scheduled. To turn the station off, change the position of the main dial, to “OFF”.

**HINT:** If you wish to alter the default value from 10 mins to some other value and set this as the new default time. Turn the dial to “Run Single Station” press the  button. Then alter the run time using the  or  buttons. Once the new default time is set press the  button again, and the new default will now always appear when you select a “manual single station”.

## Run a System Test

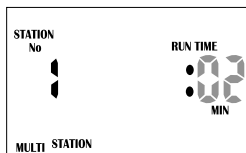

To manually run a system test turn the dial to the “System Test or Run Single Station” position, press  and  together.

The display will show:





The default run time for a single station is 2 minutes.







If you wish to alter the run time for **this start only**, use

the  and  buttons. Once the correct run time has been entered, turn the station on and make it run by pressing the  button.

# MANUAL OPERATIONS

The controller will start running all stations with the selected run time. The time will decrement in the display and will sequentially move through all stations, running them for the same set period of time. This option is designed so that it is possible to test all sprinklers and valves that make up the irrigation design.

To skip to the next station press the  button. To go back a station press the  button. To stop the system test, change the position of the main dial, to “OFF”.

**HINT:** If you wish to alter the default value from 2 mins to some other value and set this as the new default time, press the  and  together followed by  button. Then alter the run time using the  or  buttons. Once the new default time is set press the  button again, and the new default will now always appear when you select a “manual system test”.

## Run a Program

To manually run a complete program or to stack multiple programs to run, rotate the dial to “Run Program”. The word “OFF” will be flashing.

The display will show:

To enable program 1 to start press the  button. The icon “OFF” will change to “ON”.

This program has now been enabled so that it can be run. To make program 1 run, press the  button.

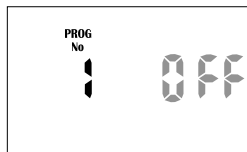



**NOTE:** So long as there are run times in program 1 then program 1 will start and water the stations associated with it.





# MANUAL OPERATIONS

There may be times when it is desirable to run more than one program manually. The controller allows this to occur using its unique facility of enabling a program, before running it. For example if I wished to run Program 1 and also Program 2, the controller will manage stacking of the programs so they do not overlap.

Enable program 1 by pressing the  button. To select the next program press the  button, the program number will increment to program 2.

Enable program 2 to run by pressing the  button.

**NOTE:** to disable a program number, press the  button.

Once both programs have been enabled, they can be run by pressing the  button. The controller will now run all programs that have been enabled starting with the highest numbered program. So in this case, program 2 would run and when it has completed its cycle, program 1 would start and run its cycle.

This method can be used to enable any, or all of the available programs on the controller.

**NOTE:** When running programs in manual mode the “Budget %” will alter the running times of each individual station.

# OTHER FEATURES

## Stop Watering

To stop an automatic or manual watering schedule, turn the dial to the “OFF” position.

***NOTE:** For automatic watering remember to turn the dial back to the “Auto Run” position, as “OFF” will stop any future watering cycles from occurring.*

## Stacking Start Times

Should you accidentally set the same watering start time on more than one program, the controller will “stack” them in sequential order. All programmed start times will be watered from the highest number first.

## Automatic Backup

This product is fitted with permanent memory. This allows the controller to hold all stowed values even in the absence of power sources, which means that programmed information will never be lost. Fitting the 9 volt block battery will keep the real time clock running during power outages. However, if the battery is not fitted the real time clock is backed up every 10 minutes to the non volatile memory. This means that when the power returns the clock will be restored to its last known value.

It is recommended that a battery is fitted and it is changed every 12 months.

A low battery icon will light when the battery has a week left to run. When this occurs, replace the battery as soon as possible so that the clock is maintained correctly during power failures.

# OTHER FEATURES

## Rain Sensor

When installing a rain sensor, first remove the the factory fitted link between the “C” and “R” terminals shown here by the wire.





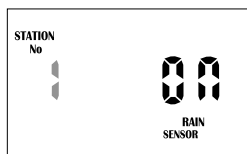

Replace with the two wires from the rain sensor into these terminals, polarity NOT required. Move the rain sensor switch on the fascia to “ON”.

Turn the dial to “Set Auxiliaries” to enable individual stations to be set rain sensor “ON” or “OFF”.

The display will show:



If the station is turned “ON” this means that the sensor will control it, should it rain. The default mode is for all stations to be rain sensor “ON”. Should you have a station (valve) that always needs to be watered, e.g. an enclosed green house or plants that are under cover, then the rain sensor can be turned “OFF” for these particular stations. This way when the sensor is wet they will still water. To select a station to turn “OFF”. Press the  button, the word “ON” will now be flashing, use the  button to change to “OFF”.

**TIP:** To turn the station back “ON” press the  button. To advance to the next station use the  button and the station number will increment. Do this operation for all stations (valves) on the controller that need to be altered.

**HINT:** To disable the rain sensor and allow all stations to water regardless of the setting, move the slide switch marked Rain/Sensor to the “OFF” position. The reactivate it slide the switch to the “ON” position.

# OTHER FEATURES

## Rain Delay (Rain sensor cont...)

Different rain sensors react in different ways. The most common complaint about rain sensors, is that they dry out too quickly, and allow the system to come on within hours of a rain storm. To counter this problem the controller has a “Rain Delay” setting that allows a specific delay time to elapse after the rain switch has dried out before the controller will water again. Turn the dial to the “Set Auxiliaries” position. Then press the  button. The rain delay value will now be flashing.

The display will show:

Press the  button to alter the rain delay time in increments of 12 hours at a time. A maximum delay of 240 hours or 10 days can be set.

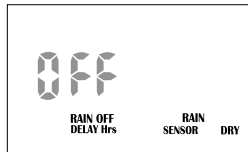

## Stop All Watering

To stop all watering cycles during winter, turn the dial to the “OFF” position.

The display will show “ALL OFF”:

This means that all automatic schedules will not come on, but the programmed information is still retained in the memory and the clock still keeps track of time even though it is no longer being displayed.



To reactivate watering, turn the dial to the “Auto Run” position.

# OTHER FEATURES

## Water Budgeting & Seasonal Adjustment

The automatic station run times can be adjusted by percentage as the seasons change. This will save valuable water as the run times can be adjusted quickly in spring, summer, and autumn to reduce or increase water usage.

Ensure the dial is in the “Auto Run” position.



Press the  button.

The display will show:

This means that the run times are set to 100%, i.e. if station 1 is set to 10 minutes then it will run for 10 minutes.

Should however the value change to say 50% then instead of running for 10 minutes station 1 would now run for 50% of 10 minutes, i.e. 5 minutes.

Conversely should the budget value be altered to show 200% then instead of running 10 minutes on station 1, it would run for 20 minutes. The budget calculation is applied to all stations and all run times that are active.

To increase the budget percentage press the , to decrease the budget percentage press the . The percentage value will increment or decrement in multiples of 10%. The maximum value is 200% and the minimum value is 10%.

To return to the clock display press the  button.

Should the budget value no longer be 100% then it will be shown in the clock display, e.g. if we set the budget to 200%

The display will show:

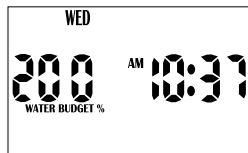
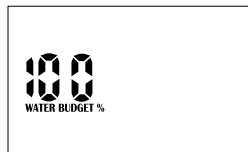

# SPECIAL FUNCTIONS

## Pump ON/OFF Selection

In most systems the water supply will be from a bore or from the mains. This controller will turn on either a pump (bore supply) or master valve (mains supply) input each time an automatic or manual start occurs. Normally the pump or master valve input is activated for all stations. However if there is a dual water supply or some of the stations may be used to run garden lights, the pump master valve input may need to be turned off for selected stations. Pumps can be assigned to be activated by a program or alternatively by individual stations. The standard default is that all programs are set to pump “ON”.

### To set pumps per program:

Turn the dial to “Set Auxiliaries”. Press the **P** button once.

The display will show:

This means we are in the pump per program menu for Pump No 1 (master valve). Press the **▶** button to enter this menu option. Program 1 will now be flashing.

The display will show:

This means that the pump will turn on when program 1 is running. To select a different program number press the

**+** or the **-** button. To turn a pump ON or OFF for a particular program press the **▶** button so that “ON” is now flashing. Press the **+** button to turn the pump ON or press the **-** button to turn the pump OFF for that particular number.

Complete this sequence for all program No’s.

### To set pumps per stations

Turn the dial to the “Set Auxiliaries” position. Press the **P** button twice and the pump per station menu will be displayed.

The display will show:

This means we are in the Pump per Station menu for Pump No 1 (master valve).

Press the **▶** button to enter this menu option.

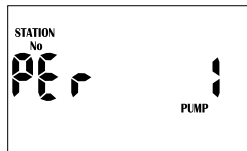
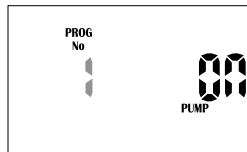
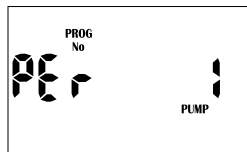





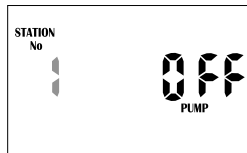

# SPECIAL FUNCTIONS

Station No 1 will now be flashing and it will be OFF.

The display will show:



This means that pump will not turn on when station No 1 is running. To turn a pump ON or OFF for a particular station

press the  button so that "OFF" is now flashing. Press the  button to turn the pump ON or press the  button to turn the pump OFF for that particular station number. Complete this sequence for all station No's by pressing  and adjust "ON" or "OFF" with the  or  buttons.

## Pressure Build



The pressure build system is used to allow the recovery of water supplies and to speed up slow valve changes within a system.

Basically what happens is, as the controller changes from one valve to another, a system delay is inserted between valves. In essence, during this delay period, the pump is working against a closed head. The advantage of this is that in systems where the valves are slow to change, it is possible to speed them up by inserting a delay period and pressurizing the main line. This system can also be used on wells and bores, where draw down can occur or cavitation of central pumps is a problem.

**WARNING:** *This option is used to make pumps work against closed heads. This can lead to pump failure, pipe splitting and in some cases, explosion of pressure vessels. Understand how to use this option and consult a hydraulic engineer regarding the use of this option in your system before implementing it.*

To access the pressure build option, turn the dial to the "Set Auxiliaries" position, press the  button until the following display appears.

The display will show:

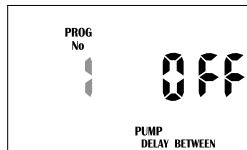

Press the  or the  buttons to increment or decrement the program number to apply the pressure build time too.



# SPECIAL FUNCTIONS

**NOTE:** each program can have its own pressure build time programmed.

To alter the pressure build time press the  button. The delay time is set to “OFF” and will now flash for the selected program number.

Use the  or the  buttons to increment or decrement the delay time seconds.

This value can be anything from OFF to 99 secs.

## Water Hammer Saver

The water hammer system is used to stop fast valve closures causing water hammer and damaging pumps and pipe work.

This facility allows the overlap of valves for a specified time between valve changes. For example the system is changing from valve one to valve two.



1. Valve one is open
2. Valve two opens
3. Time delay counts down
4. When time elapses valve one closes
5. Valve two now runs for its specified run time.

To access the water hammer feature, turn the dial to the “Set Auxiliaries” position.

Then press the  button till the following display appears.

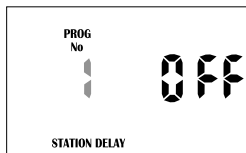
Program No 1 will be flashing. The display will show:





Press the  or the  buttons to increment or decrement the program number to apply the water hammer delay time.

**NOTE:** Each program can have its own delay time programmed.

To alter the water hammer delay time press the  button. The delay time is set to “OFF” and will now flash for the selected program number.



# SPECIAL FUNCTIONS

Use the  or the  buttons to increment or decrement the delay time seconds. This value can be anything from OFF to 99 secs.

# INSTALLATION INSTRUCTIONS

## Mounting the Controller

Install the controller near a 240 VAC outlet. Preferably located in a house, garage, or exterior electrical cubicle. For ease of operation, eye level placement is recommended. Ideally, your controller location should not be exposed to rain or areas prone to flooding or heavy water.

### INBUILT MODEL:

The inbuilt controller unit is an **outdoor** model and can be exposed to light rain as it is weather proof.

Fasten the controller using the key hole slot positioned externally on the top centre and the additional holes positioned internally under the terminal cover.

## Electrical Hook-up

### WARNING:

1. All electrical work must be carried out in accordance with these instructions following all applicable local, state and federal codes pertaining to the country of installation.  
Failure to do so will void the controller's warranty.
2. Disconnect mains power supply before any maintenance work to the controller or valves is undertaken.
3. **Do not attempt to wire any high voltage items yourself, i.e. pumps and pump contactors or hard wiring the controller power supply to the mains. This is the field of a licensed electrician. Serious injury or death could result from improper hook up. If in doubt consult your regulatory body as to what is required.**

## Field Wiring Connections

### PREPARATION

1. Prepare wire for hook-up by cutting the wires to the correct length and stripping approximately 0.25 inches (6.0mm) of insulation from the end to be connected to the controller.
2. Ensure terminal block screws are loosened sufficiently to permit easy access for wire ends. Insert stripped wire ends into the clamp aperture and tighten screws. Do not over tighten as this may damage the terminal block.

# INSTALLATION INSTRUCTIONS

3. A maximum of 0.75 Amps may be supplied by any output. Check the inrush current of your solenoid coils before connecting more than two valves to any one station.

## Power Supply Connections

### INBUILT TRANSFORMER

It is recommended that the transformer is not connected to a 240 vac supply which is also servicing or supplying motors (i.e. air conditioners, pool pumps, refrigerators). Lighting circuits are suitable as power sources.

This inbuilt transformer model, is suitable for outdoor installation as the housing is weatherproof and UV stabilized. However it is recommended that the unit be installed in an area which is not exposed directly to the weather.

### PLUG PACK MODEL

The plug pack controller unit is an indoor model and must not be exposed to rain or water.

## Terminal Block Layout (9 station example)

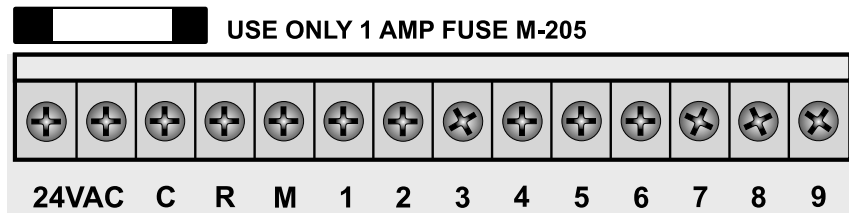

## GLOSSARY

<b>24 VAC</b>	24VAC power supply connection
<b>C</b>	Common wire connection to field wiring
<b>R</b>	Input for rain switch
<b>M</b>	Master valve or pump start output
<b>ST1-ST9</b>	Station(s) (valves) field connections

# INSTALLATION INSTRUCTIONS

## Pump Start Relay Connection (Water supply by pump system)

This controller does not provide mains power to drive a pump. A pump must be driven via an external relay and contactor setup as detailed below. The controller provides a low voltage signal that actuates the relay which in turn enables the contactor and finally the pump.

***HINT:** Although the controller has permanent memory and thus a default program will not cause erroneous valve actuation as in some controllers, it is still good practice when using a system where the water supply comes from a pump to connect unused stations on the unit back to the last used station. This in effect, inhibits the chances of the pump ever running against a closed head.*

## Single Phase Pump Installation

**USE ONLY 1 AMP FUSE M-205**

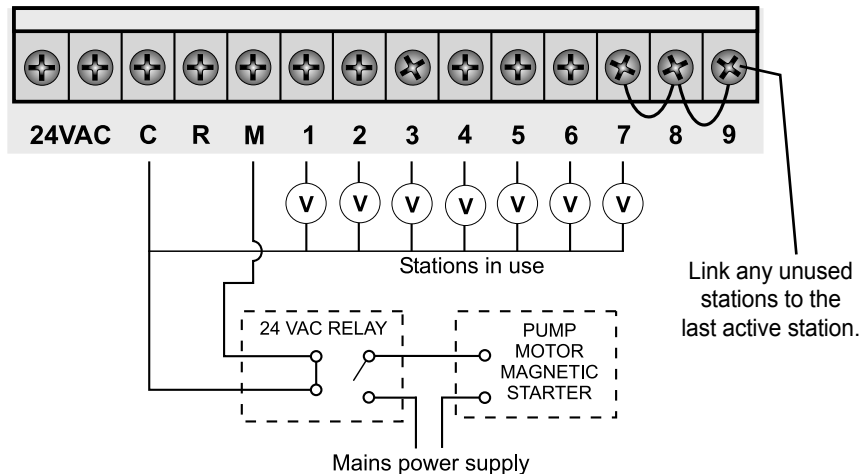

# INSTALLATION INSTRUCTIONS

## Master Valve Installation (Water supply off mains water)

The purpose of the master valve is to shut off the water supply to the irrigation system when there is a faulty valve or none of the stations are operating correctly. It's used like a back-up valve or fail safe device and is installed at the start of the irrigation system where it is connected to the water supply line.

**USE ONLY 1 AMP FUSE M-205**

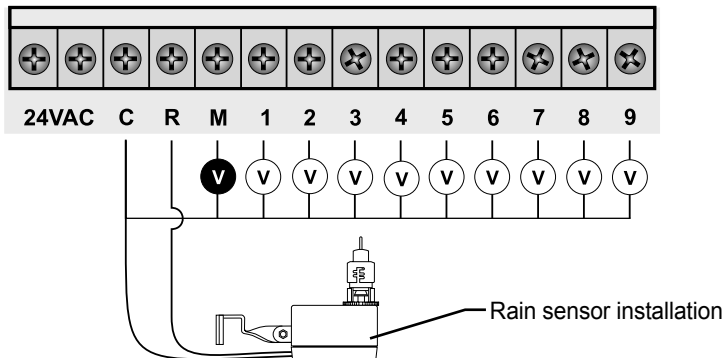

## Power Supply Connections

**USE ONLY 1 AMP FUSE M-205**

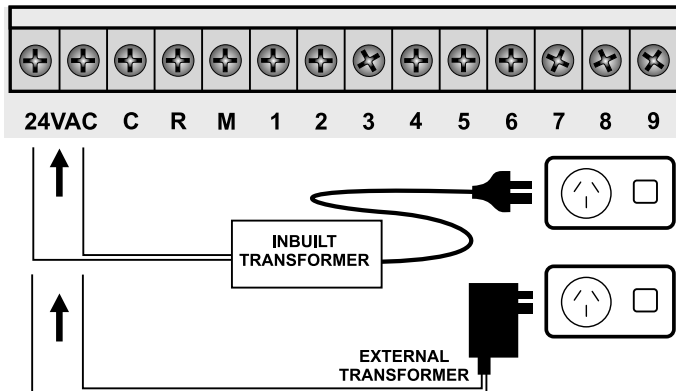

# INSTALLATION INSTRUCTIONS

## Station Valve Installation

Up to three 24 vac solenoid valves can be connected to each station output and wired back to the Common (COM) connector. When using long runs of cables, be aware that voltage drop can play a significant roll, especially when more than one coil is wired to a single station. As a good rule of thumb select your cable as follows:

0–50m	cable dia 0.5mm
50–100m	cable dia 1.0 mm
100–200m	cable dia 1.5mm
200–400m	cable dia 2.0mm

When you are using multiple valves per station the common wire needs to be much larger as it needs to carry more current. In these circumstances choose a common cable 1 or two sizes larger than required. When making connections in the field, only ever use gel filled or greased filled connectors. Most field failures occur due to poor connections. The better the connection here, and the better the waterproof seal the longer the system will perform without trouble.

**USE ONLY 1 AMP FUSE M-205**

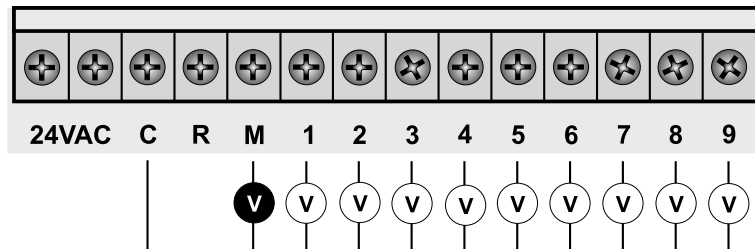

# INSTALLATION INSTRUCTIONS

## Pump Protection (System Test)

In some circumstances not all operational stations might be hooked up. For example, if the controller was capable of running 9 stations but there were only 7 field wires and solenoid valves available for connection. This situation can pose a risk to a pump when the system test routine for the controller is initiated.

The system test routine sequences through all available stations on the controller. In the above example this would mean stations 8 through to 9 would become active and would cause the pump to operate against a closed head. This could possibly cause permanent pump, pipe and pressure vessel damage.

It is mandatory if the system test routine is going to be used, that all unused, spare stations, should be linked together and then looped to the last working station with a valve on it.

Using the above example, the connector block should be wired as per the diagram below.

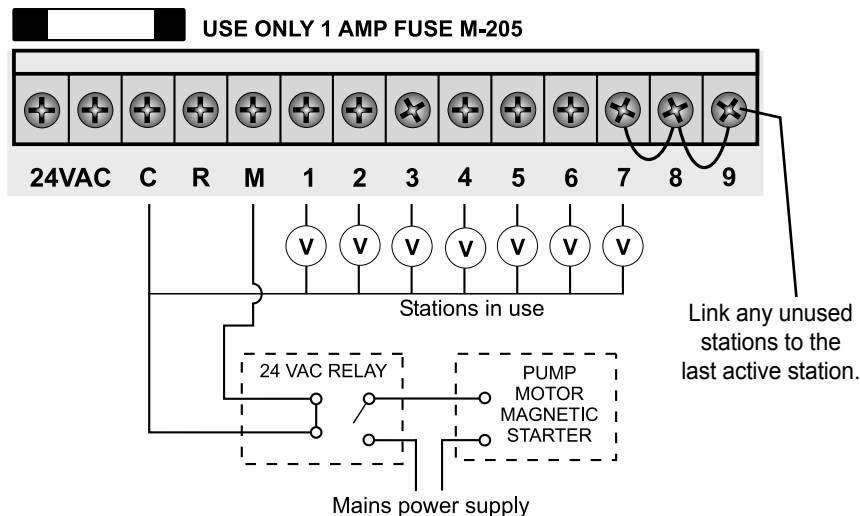

# FAULT FINDING GUIDE

<b>SYMPTOM</b>	<b>POSSIBLE CAUSE</b>	<b>SUGGESTION</b>
No display	Faulty transformer or blown fuse	Check fuse, check field wiring, check transformer
Single station not working	Faulty solenoid coil, or break in field wire	Check solenoid coil (a good solenoid coil should read around 33ohms on a multi meter). Test field cable for continuity. Test Common cable for continuity.
Fuse blows	Incorrect wiring or bad connection. Solenoid coil has shorted through	Check solenoid coil ( a good solenoid coil should read around 33ohms on a multi meter). Test field cable for continuity. Test Common cable for continuity. Test connections.
No automatic start	Programming error or blown fuse or transformer	If unit works manually then check the programming. If not then check the fuse, wiring and transformer.
Buttons not responding	Short on button or programming not correct	Check instruction book to ensure programming is correct. If buttons still not responding then return panel to supplier or manufacturer.
System coming on at random	Too many start times entered on automatic programs	Check number of start times entered on each program. All stations will run once for every start. If fault persists return panel to supplier.



# FAULT FINDING GUIDE

<b>SYMPTOM</b>	<b>POSSIBLE CAUSE</b>	<b>SUGGESTION</b>
More than one station coming on at once	Possible faulty driver triac	Check wiring and swap faulty station wire's on the controller terminal block with known working stations. If the same outputs are still locked on, return panel to supplier or manufacturer.
Pump start chattering	Faulty relay or pump contactor	Electrician to check voltage on relay or contactor.
Display cracked or missing segments	Display damaged during transportation	Return panel to supplier or manufacturer.
Sensor input not working	Sensor enable switch in the OFF position or faulty wiring	Slide switch on front panel to the ON position, test all wiring and make sure the sensor is a normally closed type. Check programming to make sure sensor is enabled.
Pump not working on a specific station or program	Programming error with pump enable routine	Check programming, using the manual as a reference and correct mistakes.

# ELECTRICAL CHARACTERISTICS

## Electrical Outputs

### POWER SUPPLY

Mains supply: This unit runs off a 240 volt 50 hertz single phase outlet.

The controller draws 30 watt at 240 VAC.

The internal transformer reduces the 240 VAC to an extra low voltage supply of 24 VAC. The internal transformer is fully compliant with AS/NZS 61558-2-6 and has been independently tested and judged to comply.

The plug pack model is 240V 24V 1 amp and suitable only for indoor installation.

ELECTRICAL POWER SUPPLY: Input 24 volts 50/60Hz

ELECTRICAL OUTPUTS: Maximum of 1.0 amp

#### **To solenoid valves:**

24 vac 50/60Hz 0.75 amps max

***Note:** up to 3 valves per station on the inbuilt model*

#### **To the master valve/pump start:**

24 vac 0.25 amps max

***Note:** Transformer and fuse capacity must be compatible with output requirements*

### OVERLOAD PROTECTION:

Standard 20mm M-205 1 amp fast blow glass fuse.

### POWER FAILURE:

The controller has permanent memory so the data is always backed up even with the absence of all power, however to maintain the real time clock as current, a 9 volt block battery should be installed. This will keep the clock time for extended periods without mains power.

### WIRING:

The output circuits should be installed and protected in accordance with wiring code for your location.

# SERVICING THE CONTROLLER

## Servicing the Controller

The controller should always be serviced by an authorised agent.





















Follow these simple steps to return the unit:

1. Turn the mains power OFF to the controller.
  - a) If the controller is hardwired, a qualified electrician will be required to remove the entire unit depending on the fault.
  - b) Proceed to either unplug and return the entire controller with transformer or disconnect the panel assembly only for servicing or repair.
2. Disconnect the 24 VAC leads at the controller 24 VAC terminals on the very left hand side of the terminal block.
3. Clearly mark or identify all valve wires according to the terminals they are connected to, (1–9). This allows you to easily wire them back to the controller, maintaining your valve watering scheme.
4. Disconnect valve wires from the terminal block.
5.
  - a) Remove the complete panel from the controller housing by unscrewing the two screws in the lower corners of the fascia. (both ends of the terminal block)
  - b) Remove the complete controller from the wall unplugging the lead.
6. Carefully wrap the panel or controller in protective wrapping and pack in a suitable box and return to your service agent or the manufacturer.

**Note:** *Tampering with the unit will void the warranty.*

7. Replace your controller panel by reversing this procedure.  
The controller should always be serviced by an authorised agent.

# SPARE WATERING PLANNER

VALVE NUMBER		PROGRAM		PROGRAM	
1	5				
2	6				
3	7				
4	8				
	9				
PROGRAM		PROGRAM		PROGRAM	
START TIME	WATERING INTERVAL	START TIME	WATERING INTERVAL	START TIME	WATERING INTERVAL
<b>Start Time 1:</b>		<b>Start Time 1:</b>		<b>Start Time 1:</b>	
Start Time 2:		Start Time 2:		Start Time 2:	
Start Time 3:		Start Time 3:		Start Time 3:	
Start Time 4:		Start Time 4:		Start Time 4:	
Start Time 5:		Start Time 5:		Start Time 5:	
Start Time 6:		Start Time 6:		Start Time 6:	
<b>Start Time 1:</b>		<b>Start Time 1:</b>		<b>Start Time 1:</b>	
Start Time 2:		Start Time 2:		Start Time 2:	
Start Time 3:		Start Time 3:		Start Time 3:	
Start Time 4:		Start Time 4:		Start Time 4:	
Start Time 5:		Start Time 5:		Start Time 5:	
Start Time 6:		Start Time 6:		Start Time 6:	
<b>Start Time 1:</b>		<b>Start Time 1:</b>		<b>Start Time 1:</b>	
Start Time 2:		Start Time 2:		Start Time 2:	
Start Time 3:		Start Time 3:		Start Time 3:	
Start Time 4:		Start Time 4:		Start Time 4:	
Start Time 5:		Start Time 5:		Start Time 5:	
Start Time 6:		Start Time 6:		Start Time 6:	
<b>1</b>	<b>4</b>	<b>4</b>	<b>4</b>	<b>4</b>	<b>4</b>
<b>2</b>	<b>5</b>	<b>5</b>	<b>5</b>	<b>5</b>	<b>5</b>
<b>3</b>	<b>6</b>	<b>6</b>	<b>6</b>	<b>6</b>	<b>6</b>
STATION	STATION	STATION	STATION	STATION	STATION
1	1	1	1	1	1
2	2	2	2	2	2
3	3	3	3	3	3
4	4	4	4	4	4
5	5	5	5	5	5
6	6	6	6	6	6
7	7	7	7	7	7
8	8	8	8	8	8
9	9	9	9	9	9
1	1	1	1	1	1
2	2	2	2	2	2
3	3	3	3	3	3
4	4	4	4	4	4
5	5	5	5	5	5
6	6	6	6	6	6
7	7	7	7	7	7
8	8	8	8	8	8
9	9	9	9	9	9
1	1	1	1	1	1
2	2	2	2	2	2
3	3	3	3	3	3
4	4	4	4	4	4
5	5	5	5	5	5
6	6	6	6	6	6
7	7	7	7	7	7
8	8	8	8	8	8
9	9	9	9	9	9
1	1	1	1	1	1
2	2	2	2	2	2
3	3	3	3	3	3
4	4	4	4	4	4
5	5	5	5	5	5
6	6	6	6	6	6
7	7	7	7	7	7
8	8	8	8	8	8
9	9	9	9	9	9
1	1	1	1	1	1
2	2	2	2	2	2
3	3	3	3	3	3
4	4	4	4	4	4
5	5	5	5	5	5
6	6	6	6	6	6
7	7	7	7	7	7
8	8	8	8	8	8
9	9	9	9	9	9
1	1	1	1	1	1
2	2	2	2	2	2
3	3	3	3	3	3
4	4	4	4	4	4
5	5	5	5	5	5
6	6	6	6	6	6
7	7	7	7	7	7
8	8	8	8	8	8
9	9	9	9	9	9

# SPARE WATERING PLANNER

VALVE NUMBER		PROGRAM		PROGRAM		PROGRAM	
START TIME	WATERING INTERVAL	STATION	RUN TIME (minutes)	START TIME	WATERING INTERVAL	STATION	RUN TIME (minutes)
1							
2							
3							
4							
<b>PROGRAM</b>		<b>PROGRAM</b>		<b>PROGRAM</b>		<b>PROGRAM</b>	
<b>1</b>	Start Time 1:	1		<b>4</b>	Start Time 1:	1	
	Start Time 2:	2			Start Time 2:	2	
	Start Time 3:	3			Start Time 3:	3	
	Start Time 4:	4			Start Time 4:	4	
	Start Time 5:	5			Start Time 5:	5	
	Start Time 6:	6			Start Time 6:	6	
<b>2</b>	Start Time 1:	1		<b>5</b>	Start Time 1:	1	
	Start Time 2:	2			Start Time 2:	2	
	Start Time 3:	3			Start Time 3:	3	
	Start Time 4:	4			Start Time 4:	4	
	Start Time 5:	5			Start Time 5:	5	
	Start Time 6:	6			Start Time 6:	6	
<b>3</b>	Start Time 1:	1		<b>6</b>	Start Time 1:	1	
	Start Time 2:	2			Start Time 2:	2	
	Start Time 3:	3			Start Time 3:	3	
	Start Time 4:	4			Start Time 4:	4	
	Start Time 5:	5			Start Time 5:	5	
	Start Time 6:	6			Start Time 6:	6	

# SPARE WATERING PLANNER

VALVE NUMBER		PROGRAM		PROGRAM	
1	5				
2	6				
3	7				
4	8				
	9				
PROGRAM		START TIME	WATERING INTERVAL	START TIME	WATERING INTERVAL
<b>1</b>	START TIME 1:			START TIME 1:	
	START TIME 2:			START TIME 2:	
	START TIME 3:			START TIME 3:	
	START TIME 4:			START TIME 4:	
	START TIME 5:			START TIME 5:	
	START TIME 6:			START TIME 6:	
<b>2</b>	START TIME 1:			START TIME 1:	
	START TIME 2:			START TIME 2:	
	START TIME 3:			START TIME 3:	
	START TIME 4:			START TIME 4:	
	START TIME 5:			START TIME 5:	
	START TIME 6:			START TIME 6:	
<b>3</b>	START TIME 1:			START TIME 1:	
	START TIME 2:			START TIME 2:	
	START TIME 3:			START TIME 3:	
	START TIME 4:			START TIME 4:	
	START TIME 5:			START TIME 5:	
	START TIME 6:			START TIME 6:	
<b>4</b>	START TIME 1:			START TIME 1:	
	START TIME 2:			START TIME 2:	
	START TIME 3:			START TIME 3:	
	START TIME 4:			START TIME 4:	
	START TIME 5:			START TIME 5:	
	START TIME 6:			START TIME 6:	
<b>5</b>	START TIME 1:			START TIME 1:	
	START TIME 2:			START TIME 2:	
	START TIME 3:			START TIME 3:	
	START TIME 4:			START TIME 4:	
	START TIME 5:			START TIME 5:	
	START TIME 6:			START TIME 6:	
<b>6</b>	START TIME 1:			START TIME 1:	
	START TIME 2:			START TIME 2:	
	START TIME 3:			START TIME 3:	
	START TIME 4:			START TIME 4:	
	START TIME 5:			START TIME 5:	
	START TIME 6:			START TIME 6:	
STATION	STATION	STATION	STATION	STATION	STATION
1	1	1	1	1	1
2	2	2	2	2	2
3	3	3	3	3	3
4	4	4	4	4	4
5	5	5	5	5	5
6	6	6	6	6	6
7	7	7	7	7	7
8	8	8	8	8	8
9	9	9	9	9	9
1	1	1	1	1	1
2	2	2	2	2	2
3	3	3	3	3	3
4	4	4	4	4	4
5	5	5	5	5	5
6	6	6	6	6	6
7	7	7	7	7	7
8	8	8	8	8	8
9	9	9	9	9	9
1	1	1	1	1	1
2	2	2	2	2	2
3	3	3	3	3	3
4	4	4	4	4	4
5	5	5	5	5	5
6	6	6	6	6	6
7	7	7	7	7	7
8	8	8	8	8	8
9	9	9	9	9	9
1	1	1	1	1	1
2	2	2	2	2	2
3	3	3	3	3	3
4	4	4	4	4	4
5	5	5	5	5	5
6	6	6	6	6	6
7	7	7	7	7	7
8	8	8	8	8	8
9	9	9	9	9	9

# SPARE WATERING PLANNER

VALVE NUMBER		5	6	7	8	9
<b>PROGRAM 1</b>	START TIME					
	WATERING INTERVAL					
STATION	START TIME (minutes)	WATERING INTERVAL	START TIME	WATERING INTERVAL	START TIME	RUN TIME (minutes)
<b>1</b>	Start Time 1:		Start Time 1:		1	
	Start Time 2:		Start Time 2:		2	
	Start Time 3:		Start Time 3:		3	
	Start Time 4:		Start Time 4:		4	
	Start Time 5:		Start Time 5:		5	
	Start Time 6:		Start Time 6:		6	
	Start Time 7:	Start Time 7:	7			
<b>2</b>	Start Time 1:		Start Time 1:		8	
	Start Time 2:		Start Time 2:		9	
	Start Time 3:		Start Time 3:		1	
	Start Time 4:		Start Time 4:		2	
	Start Time 5:		Start Time 5:		3	
	Start Time 6:		Start Time 6:		4	
	Start Time 7:	Start Time 7:	5			
<b>3</b>	Start Time 1:		Start Time 1:		6	
	Start Time 2:		Start Time 2:		7	
	Start Time 3:		Start Time 3:		8	
	Start Time 4:		Start Time 4:		9	
	Start Time 5:		Start Time 5:		1	
	Start Time 6:		Start Time 6:		2	
	Start Time 7:	Start Time 7:	3			
<b>4</b>	Start Time 1:		Start Time 1:		4	
	Start Time 2:		Start Time 2:		5	
	Start Time 3:		Start Time 3:		6	
	Start Time 4:		Start Time 4:		7	
	Start Time 5:		Start Time 5:		8	
	Start Time 6:		Start Time 6:		9	
	Start Time 7:	Start Time 7:	1			
<b>5</b>	Start Time 1:		Start Time 1:		2	
	Start Time 2:		Start Time 2:		3	
	Start Time 3:		Start Time 3:		4	
	Start Time 4:		Start Time 4:		5	
	Start Time 5:		Start Time 5:		6	
	Start Time 6:		Start Time 6:		7	
	Start Time 7:	Start Time 7:	8			
<b>6</b>	Start Time 1:		Start Time 1:		9	
	Start Time 2:		Start Time 2:		1	
	Start Time 3:		Start Time 3:		2	
	Start Time 4:		Start Time 4:		3	
	Start Time 5:		Start Time 5:		4	
	Start Time 6:		Start Time 6:		5	
	Start Time 7:	Start Time 7:	6			

# GUARANTEE

The manufacturer Guarantees to the original purchaser that any product supplied by the manufacturer will be free from defects in materials and workmanship for a period of five years from the date of purchase. Any product found to have defects in material or workmanship within the period of this Guarantee shall be repaired or replaced by the manufacturer **FREE OF CHARGE**.

The guarantor does not guarantee the fitness for a particular purpose of its products and does not make any guarantee, expressed or implied, other than the guarantee contained herein. The guarantor shall not be liable for any loss from use of the product or incidental or consequential damages including damages to other parts of any installation of which this product is part.

The guarantee shall not apply to any equipment which is found to have been improperly installed, set up or used in any way not in accordance with the instructions supplied with this equipment, or to have been modified, repaired or altered in any way without the express written consent of the company. This guarantee shall not apply to any batteries or accessories used in the equipment covered under this guarantee or to any damage which may be caused by such batteries.

If the Controller develops a fault, the product or panel must be returned in adequate packing with:

1. A copy of your original invoice.
2. A description of any fault.

It is the purchasers responsibility to return the controller to the manufacturer or their agent by prepaid freight.



**HOLMAN INDUSTRIES**



## HEAD OFFICE / SERVICE

463 Scarborough Beach Road  
Osborne Park, WA 6017  
Tel: +61 8 9204 1011  
Fax: +61 8 9204 1013

## VICTORIAN WAREHOUSE

94 Northgate Drive  
Thomastown, VIC 3074  
Tel: 03 9464 5355  
Fax: 03 9464 5366

Email: [sales@holmanindustries.com.au](mailto:sales@holmanindustries.com.au)  
[www.holmanindustries.com.au](http://www.holmanindustries.com.au)