

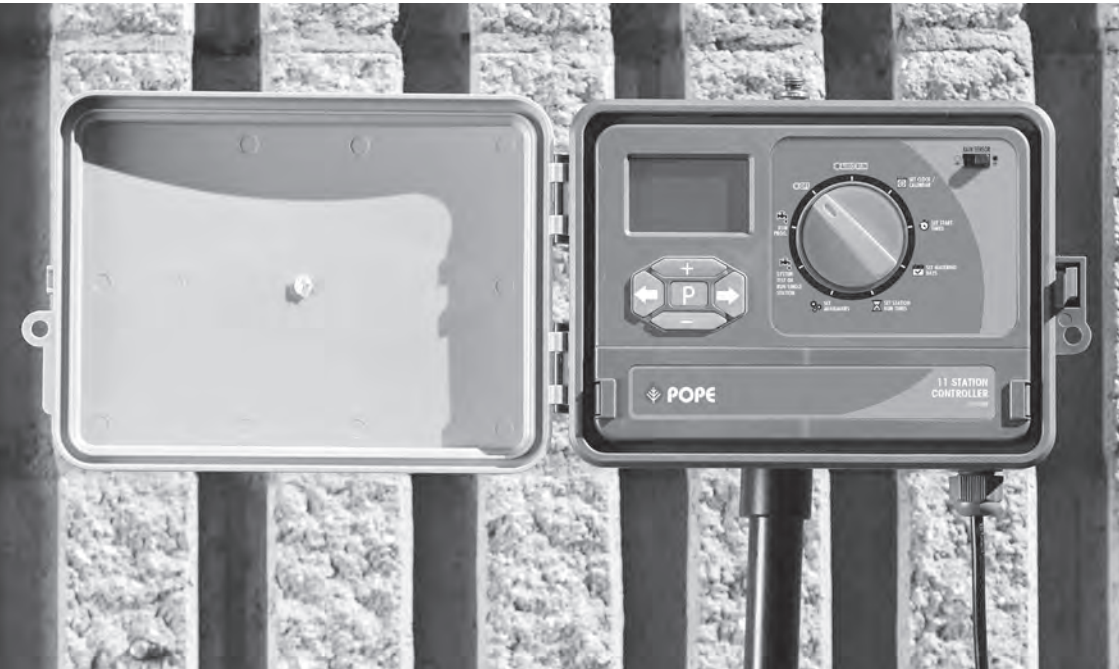

EZY PRO IRRIGATION

1010399



User Manual

TABLE OF CONTENTS

Table of Contents	2	Water Budgeting and Seasonal Adjustment	15
Introduction	3	Master Valve On/Off Selection	16
The Controller	4	Pump Delay	16
Introduction to Programming		Station Delay	17
Watering Schedules	5	Installation Instructions	18
Filling Out the Watering Schedule Form	6	Mounting the Controller	18
Setting the Time and Date	7	Electrical Wiring	18
Setting the Time	7	Wiring the Solenoid Valves	18
Setting the Date	7	Rain Sensor	19
Setting up Watering Programs	8	Pump Start Relay Connection	19
Setting Start Times	8	Specification	20
Setting Watering Days	8	Troubleshooting	21
Setting Station Run Times	8	Appendix A	
Suspending Automatic Watering	10	Guidelines for Watering	22
Clearing all Programs	10	Appendix B	
Manual Watering	11	Watering Schedule Planners	23
Running a System Test	12		
Running a Program	13		
Rain Sensor	14		
Setting a Rain Delay	14		

INTRODUCTION

The Pope Ezy Pro Irrigation Controller is a programmable electronic timer that controls the watering of six or eleven stations (depending on the model) using remote solenoid valves.

In a typical irrigation system, there is a Master Valve (MV) which is switched on whenever one of the Station Valves (SV) is on.

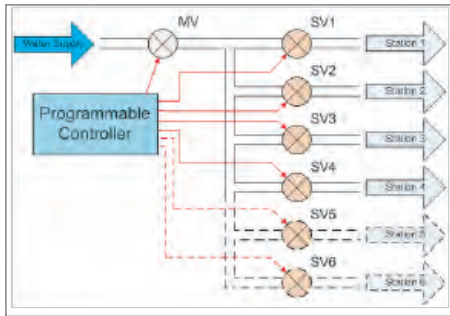

Typical Irrigation System

The Controller is also suitable for use on water supplies derived by pump from a bore or a dam. In this case, the Master Valve control line is used to turn on a Pump Start relay which controls the power to the pump. The Pump Start relay is not supplied with the controller. A Relay should be installed by a qualified electrician.

Note that the Ezy Pro Controller will not power the pump; it will only control an auxiliary relay that switches power to the pump.

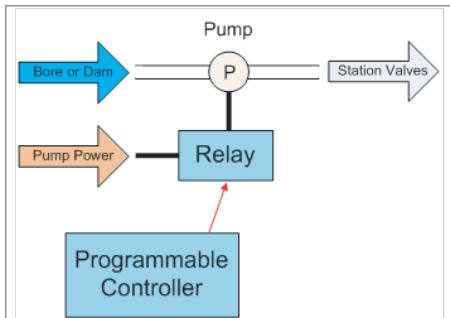

Using a Pump Control Relay

FEATURES

- Easy to install and program.
- 6 individual Programs.
- 6 individual Start Times per Program.
- 3 different watering cycles – day of the week, odd/even days, and interval.
- Water Budget feature which provides easy adjustment of watering for seasonal or weather conditions.
- Rain Sensor function (external sensor required) to prevent watering when it has rained.
- Pump delay feature (for use with a bore or dam pump).
- Station delay feature used to prevent or reduce issues caused by slow closing solenoid valves.
- Permanent memory for the retention of all programmed information. In the event of a loss of mains power, data will be saved for up to 5 years. This occurs even if a backup 9V battery is not fitted.
- Battery back-up (9V battery supplied).
- Weather resistant controller with 240VAC power lead and plug.

THE CONTROLLER

The Controller has the following features, which will be explained in detail throughout this manual:

Control Dial

used to select functions:

- **OFF**
stops irrigation
- **AUTO RUN**
automatically run watering programs
- **SET CLOCK/CALENDAR**
set the date and time
- **SET START TIMES**
set the watering start times
- **SET WATERING DAYS**
set the days that watering is to occur
- **SET STATION RUN TIMES**
set the durations of programmed watering

Control Buttons

used to navigate through the programming sequences

• SET AUXILIARIES

- **Rain Sensor**
turn on/off the rain sensor function
- **Main Valve/Pump Start**
- **Pump Delay**
Turns the pump on first and then the station after a delay, allowing for pressure to build.
- **Station Delay**
Delays the opening of the next station on sequence to give time for the previous station to close. Useful for slow to close valves.

• SYSTEM TEST or RUN SINGLE STATION

• RUN PROG.

LCD Display

Backup Battery, Control Wiring Terminals

(beneath a cover)

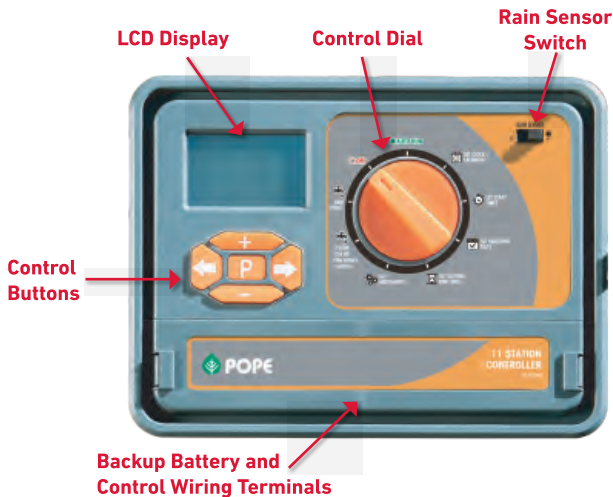

Control Panel

Note: If the mains power to the unit is off, to conserve battery energy, the LCD display automatically switches off after about 15 seconds of operator inactivity. Press **P** to see the display again. When mains power is off, the controller does not run the automatic programs, but the clock/calendar and all program information is retained

INTRODUCTION TO PROGRAMMING WATERING SCHEDULES

When programming the controller, there are the following to consider:

STATIONS OR ZONES

your controller has either six (6) or eleven (11) Stations, depending on the model. Each Station has a group of sprinklers in a specific portion (Zone) of the garden and is controlled by a solenoid Valve. Zones are generally laid out according to the type of plant material being watered and the type and flow rate of the sprinklers used to distribute the water.

PROGRAMS

up to six (6) watering **Programs** can be set and applied to any of the **Stations**. For each **Program**, the following are programmable:

- **Watering Days**

watering may be programmed to occur on

- fixed days of the week (eg. Mon, Wed and Fri),
- at intervals of a number of days (eg. every third day), or
- on odd or even days of the month (eg. 1st, 3rd, 5th, 7th etc.)

- **Start Time**

each program may have up to six (6) Start Times

- **Run Time**

each **Station (or Zone)** has an associated **Run Time**

Programming is a lot easier if you first fill out a **Watering Schedule Form**, an example of which is on the next page. You will have a record of your watering schedule and zone locations which can be kept with your controller. In the example, four **Programs** have been programmed:

- Program 1 starts at 7:00am on Mondays and Thursdays and runs for 20 minutes on Stations 1, 2, 3, 5 and 6
- Program 2 starts at 9:00pm every day and runs for 10 minutes on Stations 3 and 6. Note that if no Watering Days are programmed, the Ezy Pro Controller defaults to every day
- Program 3 starts at 6:00am every third day and runs for 10 minutes on Station 4 only
- Program 4 starts at 5:00am on Tuesdays and Sundays and runs for 30 minutes on Station 6 only.

Note: The Controller runs all programmed watering sequentially, with only one Valve open at any given time. In the example, Program 1 will water Station 1, then Station 2, then Station 3, then Station 5 and then Station 6, beginning at 7:00am, and taking a total time of 100 minutes.

If another Program was scheduled to start at say 8:00am, it would be delayed until 8:40am (the completion of Program 1).

Therefore, when scheduling multiple programs and/or multiple start times within each program, make sure that each program cycle can run to completion before the next program cycle is scheduled to start. If you do not do this, the Controller will automatically stack them in sequence.

FILLING OUT WATERING SCHEDULE FORM

VALVE NUMBER

In the area at the top of the form, fill in the area and/or type of lawn or garden which is to be watered by each Valve. In the example, three of the valves are watering turf (lawn), two are watering flowers and one is watering vegetables.

WATERING DAYS







For each Program (1 to 6), write in the days of the week that watering is required (eg. Mon, Wed, Fri), or the interval between waterings (eg. 3 days – water every third day), or Odd or Even if restricted watering is imposed, based on your house number.

RUN TIME (minutes)

For each of the Programs and each of the Stations, write in the Run Time required. Run time can be set to any time between 1 minute and 12 hours and 59 minutes.

START TIME

Write in the Start Times for each of the six Programs. Each program can have up to six assigned start times.

VALVE NUMBER				PROGRAM					
1	Front turf				5	Flower bed			
2	Front turf				6	Vegetables			
3	Back turf								
4	Flower bed								
PROGRAM	START TIME	WATERING DAYS	Station	RUN TIME	PROGRAM	START TIME	WATERING DAYS	Station	RUN TIME
	1	7:00 am	Monday Thursday	1 20		4	5:00 am	Tuesday Sunday	1
1	2		2	20	4			2	
	3		3	20				3	
	4		4					4	
	5		5	20				5	
	6		6	20				6	30
	2		9:00 pm					1	
2	2		2		20				
3	3	10	3		20				
4	4		4						
5	5		5		20				
6	6	10	6		20				
3	8:00 am	Every third day	1		6			1	
	2		2					2	
	3		3					3	
	4		4	10				4	
	5		5					5	
	6		6					6	

Sample Six Station Watering Schedule Form

SETTING THE TIME AND DATE



Control Switch

SETTING THE TIME

- 1 Select **Set Clock/Calendar** on the **Control Dial**. This will cause the **HOUR** to flash.
- 2 Use the **+** and **-** buttons to adjust the hour to the correct value. Note that the clock is 12 hour so ensure that the correct **AM** or **PM** is displayed.
- 3 Press **→** and **MIN** will flash.
- 4 Use the **+** and **-** buttons to adjust the minutes to the correct value.

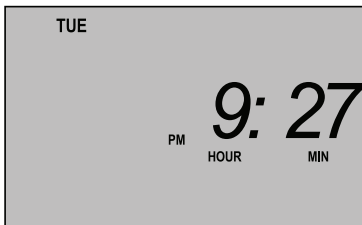

SETTING THE DATE

- 1 Select **Set Clock/Calendar** on the **Control Dial**. This will cause the **HOUR** to flash.
- 2 Press **←** and **DAY** will flash.
- 3 Use the **+** and **-** buttons to adjust the day to the correct value.
- 4 Press **←** and **MONTH** will flash.
- 5 Use the **+** and **-** buttons to adjust the month to the correct value.
- 6 Press **←** and **YEAR** will flash.
- 7 Use the **+** and **-** buttons to adjust the year to the correct value.



Note: If the 9V backup battery is not fitted, or is flat, when mains power is lost, the controller memory updates every 10 minutes. When power is restored, the clock resumes at the last updated time, which may differ from the correct time by up to 10 minutes.

SETTING UP WATERING PROGRAMS

Up to six Programs may be entered, each requiring the programming of:

- **Watering days** – applied to all Station numbers and Start Times
- **Start times** – up to six
- **Station numbers** - up to four or six, depending on the model
- **Station Run Times** – may be different for each Station

For example, Program 3 may be set to water on Mondays and Thursdays (Watering Days), at 7am and 7pm (Start Times), and water Station 1 for 20 minutes, Station 2 for 10 minutes, and Station 4 for 30 minutes (Run Times).

An example of the use of six start times is the watering of a new lawn in very hot weather. It might be watered for 10 minutes at 6am, 10am, 1pm, 3pm and 5pm.

SETTING START TIMES

- 1 Select **SET START TIMES** on the **Control Dial**. This will cause the **START No** to flash.
- 2 Press **P** to select the required **Program**.
- 3 Use **+** and **-** to select the **Start No** required.
- 4 Press **↔** and **OFF** will flash (if a start time has previously been set, then the **Hours** will flash).
- 5 Use **+** and **-** to select the **Start Time Hours** required.
- 6 Press **↔** and **MIN** will flash.
- 7 Use **+** and **-** to select the **Start Time Minutes** required.
- 8 To add a second start time, press **↔** until **Start Number 1** flashes, press **+** to change start number to 2. Repeat steps 4-7 for **Start Number 2**
- 9 Repeat steps 2 to 7 until all **Start Times** have been programmed for all Programs.

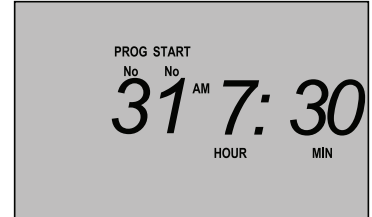
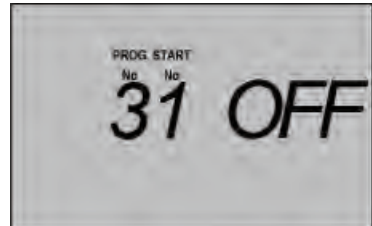

SETTING WATERING DAYS

There are three ways to set **Watering Days**:

- **Calendar Schedule**
water on specific days of the week (eg. Monday, Wednesday and Friday). This is a seven day schedule which starts on Monday and ends on Sunday.
- **Interval Schedule**
water at intervals of a selected number of days (eg. every third day). Available intervals are from 1 (water every day) to 15 (water every 15th day).
- **Odd/Even Schedule**
water on odd or even numbered days of the month (useful in times of drought when watering restrictions are in place).

SETTING UP WATERING PROGRAMS

To program **Watering Days**:

- 1 Select **SET WATERING DAYS** on the **Control Dial**. One of three screens will appear. On the first screen, one of the days of the week will be flashing. On the second screen, **ODD** may be replaced by **EVEN**. On the third screen, **INTERVAL DAYS** is displayed.
- 2 Press **P** until **PROG No** indicates the desired program (1, 2, 3, 4, 5 or 6).

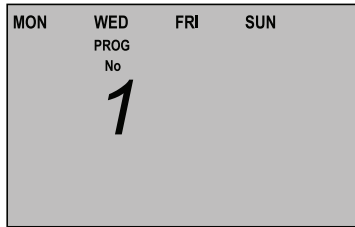

- 3 Press **←** or **→** to move to the appropriate screen.
 - a. To select specific **Watering Days**, press **←** until **MON** is flashing. Press **+** if watering is required on Monday, or press **-** if it is not. Repeat for each of the other days of the week. When a day has been deselected, it will no longer be displayed. Only those days when watering is to occur will be displayed.

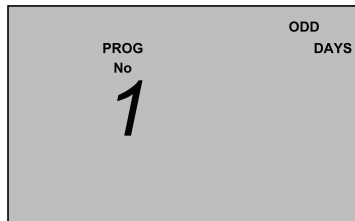

- b. To select **ODD** or **EVEN**, press **←** or **→** until the desired **ODD** or **EVEN** is displayed.
- c. To select a watering Interval, press **←** until the number of **INTERVAL DAYS** is flashing. Press **+** or **-** until the desired number is displayed. The interval may be any number of days from 1 to 15. Then press **←**, the lefthand number will flash. Press **+** or **-** to change this number to reflect the current day in the cycle. For example if set to 0 with a 4 day interval, the next irrigation would occur in 3 days. If set to 2 in a 3 day interval the next irrigation would occur a day later.



- 4 Repeat steps 2 and 3 until **Watering Days** have been programmed for all **Programs**.

SETTING UP WATERING PROGRAMS

SETTING STATION RUN TIMES

The Station Run Time is the length of time the Station will water during the programmed watering cycle. Run times can be set from 0 (off) to 12 hours, 59 minutes, in one-minute increments.

A Station is assigned to a Program when it is given a run time. If the run time for a Station is set to zero (0:00) in a program, that Station will not be watered in that Program.

In the example below, Program 1 has been set to water Station 2 for 30 minutes.

- 1 Select **SET STATION RUN TIMES** on the **Control Dial**. This will cause the **Station No** to flash.
- 2 Use the **P** button to select the **Program** required.
- 3 Use the **+** and **-** buttons to select the **Station** number.
- 4 Press **↔** and **HOUR** will flash. Use the **+** and **-** buttons to set the number of hours of watering required on that Station. Typically, this will be 0, but could be up to 12.
- 5 Press **↔** and **MIN** will flash. Use the **+** and **-** buttons to set the number of minutes of watering required on that Station.
- 6 Repeat steps 2 to 5 until all **Station Run Times** have been programmed for all **Programs**.



SUSPENDING AUTOMATIC WATERING

To stop all automatic watering cycles, turn the **Control Dial** to **OFF**. The display will show **ALL OFF**.

All programmed information will be retained and the clock will continue to run.

To resume the programmed watering schedules, turn the **Control Dial** to **AUTO RUN**. Irrigation will begin from the next scheduled start time.

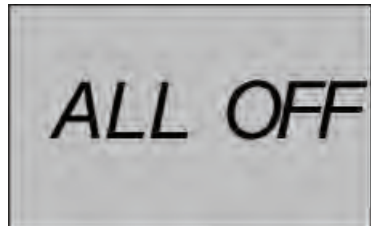

CLEARING ALL PROGRAMS

All programmed information can be cleared.

- 1 Select **AUTO RUN** on the **Control Dial**.
- 2 Press and hold the **+**, **-**, **↔** and **↔** buttons simultaneously for 5 seconds.

This removes all programming but does not reset the clock and calendar.

MANUAL WATERING

A single selected Station can be watered for a selected period of time.

- 1 Select **SYSTEM TEST** or **RUN SINGLE STATION** on the **Control Dial**. The **Station Number** will flash.
- 2 Use the **+** and **-** buttons to select the Station to be run. **RUN TIME** can be set to any time between 1 minute and 12 hours and 59 minutes
- 3 Press **←** and **RUN TIME HOUR** will flash. Use the **+** and **-** buttons to select the number of hours that you want to water.
- 4 Press **→** and **RUN TIME MIN** will flash. Use the **+** and **-** buttons to select the number of minutes that you want to water.
- 5 Press **P** to start watering the selected Station for the selected time.

The display will countdown the time remaining.

To stop watering at any time before the end of the selected period, turn the **Control Dial** to **OFF**.

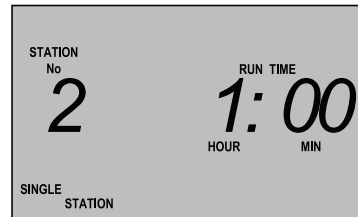

RUNNING A TEST SYSTEM

The system may be tested by setting selected stations to water for short times. For example, you might set **Station 2** to water for 2 minutes, or multiple Stations 1, 2 and 3 to water for 1 minute each

To test a single **Station**:

- 1 Select **SYSTEM TEST** or **RUN SINGLE STATION** on the **Control Dial**. **SINGLE STATION** will be displayed in the bottom left corner of the screen.
- 2 Press **+** or **-** to select a Station to test.
- 3 Press **→** to move to the **RUN TIME** for the **Station**.
- 4 Press **+** or **-** to adjust the **Run Time**.
- 5 Press **P** to start the system test. Remaining runtime will be displayed on the screen

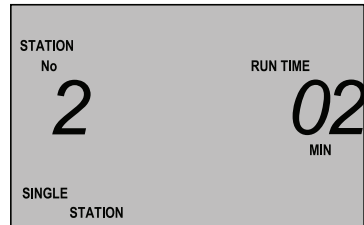

To test multiple **Stations**:

- 1 Select **SYSTEM TEST** or **RUN SINGLE STATION** on the Control Dial. **SINGLE STATION** will be displayed in the bottom left corner of the screen.
- 2 Press **+** and **→** together. The display in the bottom left corner will change to **MULTI STATION**.
- 3 Press **+** or **-** to select a **Station** to test.
- 4 Press **→** to move to the **RUN TIME** for the **Station**.
- 5 Press **+** or **-** to adjust the **Run Time**.
- 6 Press **→** until the **Station** number is flashing and repeat steps 3 to 5 to program all Stations to be tested.
- 7 Press **P** to start the system test.



Each Station with a **Run Time** set will water in sequence, beginning with the one displayed when **P** was pressed.

Make sure that any valve that you don't want to test has a runtime of 00min

To stop the test at any time, turn the **Control Dial** to **OFF**.

RUNNING A PROGRAM

To manually start a single **Program** or a number of **Programs**:

- 1 Select **RUN PROG.** on the **Control Dial**. A **Program** number will be displayed and **OFF** will be flashing.
- 2 Press **+** to change to **ON**.
- 3 Press **P** to select another of the six programs and press **+** to change to **ON**.
- 4 Repeat step 3 until all desired **Programs** have been turned on.
- 5 Press **↵** to run the test program. The watering cycles that you have programmed for the selected **Programs** will begin immediately, regardless of the **Start Time** and **Watering Days** programmed.

The controller will run all the activated programs sequentially.

If a Water Budget has been programmed, it will be applied to the watering times.

The test can be stopped temporarily for 10 minutes:

- 1 Press **P** to pause irrigating. A countdown clock will show the time remaining before the irrigation will resume.
- 2 Press **P** at any time, to restart the process

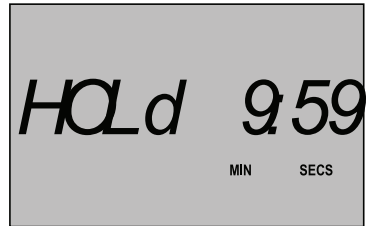
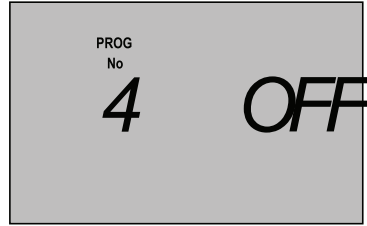

RAIN SENSOR

The Rain Sensor function requires the connection of an external rain sensor with "normally closed" contacts, such as the Pope Rain Sensor (Product Code 1010341). When sufficient rain is sensed, the relay contacts close, resulting in the suspension of the automatic watering programs.

To install and use the rain sensor:

- 1 Open the Controller box and remove the cover to reveal the Backup Battery and Control Wiring Terminals.
Note: If a rain Sensor is not connected, leave the factory link as supplied
- 2 Remove the factory fitted link between the "C" and "R" terminals.
- 3 Connect the rain sensor to the "C" and "R" terminals, bringing the 2 wire cable through a hole in the bottom of the box. The connections are not polarity sensitive.
- 4 Replace the terminal cover.
- 5 Turn ON the Rain Sensor switch in the top right corner of the control panel.
Note: If left in the OFF position, the controller ignores the condition of the Rain Sensor

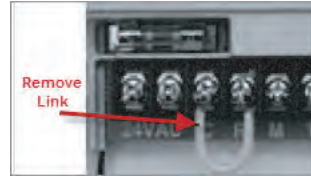

Each station can be individually set to override the rain sensor. This is useful, for example, if you have an area of your garden that is under cover and does not receive any rainfall.

The default position for the rain sensor is "off", and it must be turned "on" for each Station:

- 1 Select **SET AUXILIARIES** on the **Control Dial**. A **Station** number will be flashing and **OFF** will be displayed.
- 2 Press **←** and OFF will flash.
- 3 Press **+** to change to ON.
- 4 Press **←** and the Station number will flash.
- 5 Use **+** and **←** to select another Station number and repeat steps 2 to 4 until rain sensing is turned on for all required Stations.

Note: When OFF is selected for a station, the controller overrides the rain sensor for that particular station.

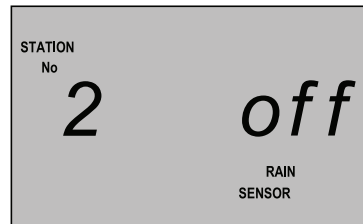

SETTING A RAIN DELAY

Programmed watering may be suspended for between 1 and 10 days, a useful feature if, for example, rain is forecast in your area for the next two days. Instead of turning the timer off (with the risk of forgetting to turn it back on), watering can be delayed for three days, after which, programmed automatic watering will resume at the next start time.

- 1 Select **SET AUXILIARIES** on the **Control Dial**. A **Station** number will be flashing and **OFF** or **ON** will be displayed.
- 2 Press **←** and the **RAIN OFF DELAY** Hrs will be flashing.
- 3 Use the **+** and **←** buttons to adjust the Delay Time, in increments of 24 hours (1 day).

Note: Manually operating a station or program ignores the Rain Delay feature.

(as an example)

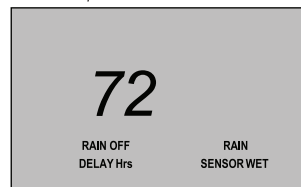





WATERING BUDGET AND SEASONAL ADJUSTMENT

Changes in season and temperature generally require a change in watering run times to maintain a healthy landscape and conserve water.

The season adjust feature enables you to change simultaneously, all programmed Run Times, in steps of 10%, from 10% of the programmed times up to 200%. The programmed Water Budget is applied to all Stations and all Programs.

A 50% setting, for example, would decrease a 20 minute Station run time to 10 minutes and a 200% setting would double it to 40 minutes.

- 1 Select **AUTO RUN** on the Control Dial. The time of day will be displayed.
- 2 Press  and the **WATER BUDGET %** will be flashing.
- 3 Use the  and  buttons to adjust the budget up or down from 100%.
- 4 Press  to display the clock. The screen also now displays the **WATER BUDGET %**.

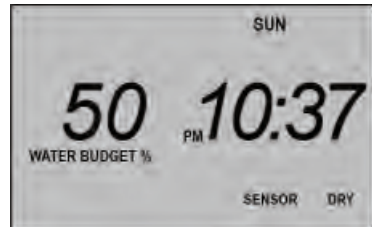

MASTER VALVE ON/OFF SELECTION

Most domestic irrigation systems operate from a town water system, or a bore or a dam (see **Introduction**).

The irrigation controller has a **Master Valve** output which is used to control a **Master Solenoid Valve** when operating with a town water supply. The use of a Master Valve is highly recommended, particularly if the pipe connections to the Station Valves are done using PVC push on and clip connections which are prone to bursting open when continuously subjected to mains water pressure.

When using water from a bore or a dam, the Master Valve control line is used to control a Pump Start Relay. The pump must be turned on with each individual Station Valve.

The default setting for the Master Valve is **OFF**. It must be turned **ON** for each individual **Station**.

To program the **Master/Pump Start** valve:

- 1 Select **SET AUXILIARIES** on the Control Dial.
- 2 Press the **P** button once and the **PEr** screen will be displayed.
- 3 Press the **P** button again and **STATION No** will be flashing and **PUMP** will show as **OFF**.
- 4 Press **←** and **OFF** will flash.
- 5 Press **+** to change to **ON**. Pressing **←** will return to **OFF**.
- 6 Press **←** and the **Station No** will flash.
- 7 Use the **+** and **←** buttons to select another **Station No** and repeat steps 4 and 5.
- 8 Repeat steps 6 and 7 until all **Master Valve** programming has been completed for all Stations.

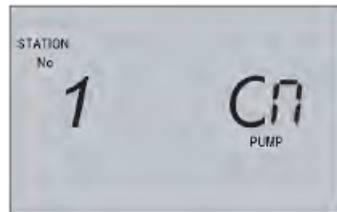

PUMP DELAY

The pump delay feature can be used to allow the recovery of a bore water supply by delaying the opening of **Station** valves. This allows the pump to operate against a closed head for a programmed period of time, pressurizing the main line. This can be useful where draw down can occur in a bore.

Different delays can be set for each **Station** and the value can be between 0 (**OFF**) and 99 seconds.

Warning

This irrigation system allows the operation of a pump against a closed head (no valves open). This has the potential to cause damage to the pump, pipes and other components in the irrigation system, resulting in explosion, and should be used only in consultation with a hydraulic engineer.

- 1 Select **SET AUXILIARIES** on the **Control Dial**.
- 2 Press the **P** button repeatedly until **PUMP DELAY BETWEEN** appears in the bottom right hand corner of the screen. The **Station No** will be flashing

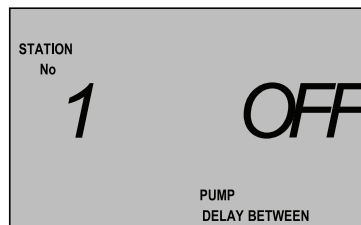

MASTER VALVE ON/OFF SELECTION

- 3 Use the **+** and **-** buttons to select the required **Station No.**
- 4 Press **←** and **OFF** will flash.
- 5 Press **+** repeatedly until the required delay time is reached (1 to 99 seconds). Setting the time to 0 or 100 will reset the delay to **OFF**.
- 6 Press **←** and the **Station No** will flash.
- 7 Repeat steps 4 to 6 until the delay has been set for all required **Stations**.

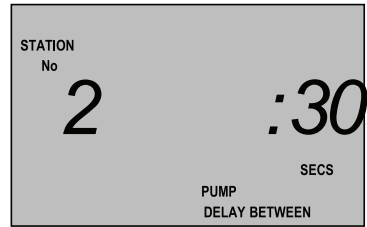

STATION DELAY

Station delay is used to reduce complications caused if one valve is slow to close and the next valve opens before that valve has closed. Station delay adds a short delay in valve operation, meaning the next valve in the watering sequence is opened slightly after the previous one is closed.

Different delays can be set for each **Station** and the value can be between 0 (**OFF**) and 99 seconds.

- 1 Select **SET AUXILIARIES** on the **Control Dial**.
- 2 Press the **P** button repeatedly until **STATION DELAY** appears in the bottom left hand corner of the screen. The **Station No** will be flashing.
- 3 Use the **+** and **-** buttons to select the required **Station No.**
- 4 Press **←** and **OFF** will flash.
- 5 Press **+** repeatedly until the required delay time is reached (1 to 99 seconds). Setting the time to 0 or 100 will reset the delay to **OFF**.
- 6 Press **←** and the **Station No** will flash.
- 7 Repeat steps 4 to 6 until the delay has been set for all required Stations.

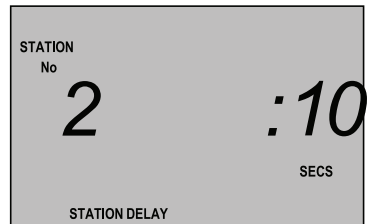
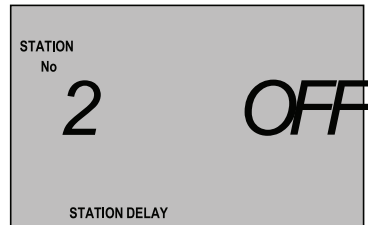

INSTALLATION INSTRUCTIONS

MOUNTING THE CONTROLLER

As the Controller comes with a 1.0m fixed power lead, select a location for the Controller within 0.9m of an outdoor electrical outlet.

For safe, reliable operation, select an installation site which will provide the following conditions:

- Protection from irrigation spray, exposure to wind, heavy rain, snow and direct sun during the hottest part of the day. The controller is intended for use outdoors and can be exposed to light rain as it is weather resistant.
- Access to a grounded power source which is not controlled by a light switch or utilized by a high current load appliance, such as a refrigerator or air conditioner.
- Access to the sprinkler control valve wiring and optional accessory wiring.

Using two screws, fix the controller to a wall using the keyhole slot on the top centre of the back of the weatherproof box, and the hole at the bottom under the terminal cover.

ELECTRICAL WIRING

Warning

High voltage (240V) electrical work must be carried out by a licensed electrician. Failure to do so will void the Controller warranty.

If the Controller is located outside, do not use a power extension lead to reach a power point more distant than 0.9m.

When the irrigation system is used on a town water supply, the only high voltage wiring needed is the provision of an electrical outlet to supply power to the Controller. Alternatively, the controller can be hard-wired to a 240V circuit. If the Controller is located outside, a suitable external power outlet is required.

If the system is used on a bore or dam water supply and a pump start relay is required, all 240V electrical work must be carried out by a qualified electrician.

WIRING THE SOLENOID VALVES

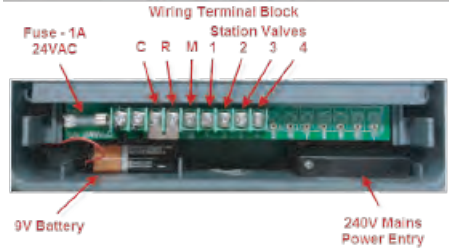

Terminal Block, Backup Battery and Fuse Compartment

Low voltage wiring to the solenoid valves does not require a licensed electrician.

Disconnect the controller from the mains power supply before connecting the valves or performing any maintenance work on the Controller or valves.

Solenoid valves have two cables. One (either one can be selected) of the cables is connected individually back to terminal 1,2,3,4, etc depending on the assigned station number for the valve.

The remaining cable on each solenoid is connected to a shared "common" wire and connected to the terminal marked "C" on the controller (see diagram below)

Solenoid valves come with two wire tails which must be connected to the cable from the Controller. These connections must be made with an appropriate water proof connector, such as the 3MTM Scotchlok IDC Connector range. Connections are not polarity sensitive.

When connecting the solenoid cables to the terminal block, remove about 6mm of insulation from the end of each wire and tightly twist stranded wires before inserting into the terminal. (Terminals can accept a maximum of 2.5mm cable)

Cables to the solenoid valves and rain sensor exit the Controller through a round hole in the base of the box (next to the Mains Power Cord). You will need to cut the hole using a sharp knife or a drill. Once wires have been run through the hole and are connected to the terminals, reseal the gaps between wires and hole in controller with silicon to impede water ingress.

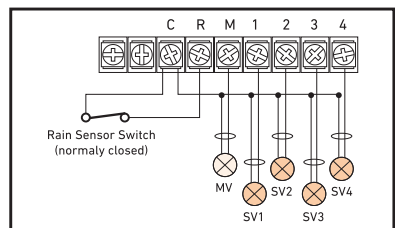

Solenoid valve Wiring

INSTALLATION INSTRUCTIONS

RAIN SENSOR

The controller is factory fitted with a link between terminals R and C. If a Rain Sensor is not to be used, then leave this link in place.

If a Rain Sensor is to be used, then remove this link and connect the rain Sensor to terminals R and C. The Rain Sensor must have normally closed contacts that open when sufficient rain is sensed.

NOTE

The solenoid valve outputs are 24VAC (maximum 0.8A) and are designed to operate one solenoid valve per Station. Connecting multiple solenoid valves to a Station output will void the warranty.

PUMP START RELAY CONNECTION

CAUTION

The controller cannot be used to power a pump motor directly. As shown in the drawing below, the controller provides 24VAC (maximum current 0.5A) to switch an auxiliary relay which switches power to the pump.

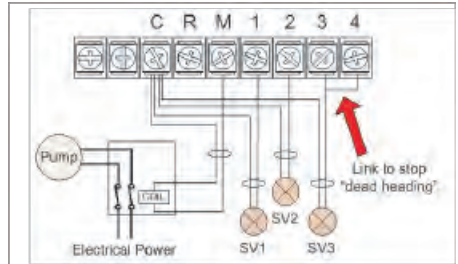

Pump Start Wiring

CAUTION

To prevent pump damage due to “dead-heading” (the pump is running, a station has inadvertently been given a run time but no valve is connected to the output terminal), connect a jumper wire from any unused station terminals to a used station terminal, as shown by the red arrow in the above diagram.

Note: In the instance shown in the diagram above, station 3 will be activated when the controller activates station 4

SPECIFICATIONS

Cabinet Dimensions

240mm x 80mm x 185mm

Power Specifications

Internal Transformer

Input: IN: 230/240VAC 50Hz

Output: OUT: 24VAC

Max Station load 0.3A

Total Master Valve Load 0.5A

Total Maximum Load 0.8A

Surge Protection

47KV normal mode

Battery Type

9 volt

Operating Temperature range

0-60°C

IP Rating

IP44

Maximum Cable size

0.5mm - 2.54mm²

TROUBLESHOOTING

Symptom	Possible Cause	Remedy
Display is blank.	Mains power is not connected AND there is no 9V battery fitted (or it is flat).	Fit a 9V battery and check that the controller is plugged in to a power point and that it is switched on. Check that there is power to the power point.
	Controller fuse has blown AND there is no 9V battery fitted (or it is flat).	Fit a 9V battery and check the fuse under the terminal cover.
	LCD screen has over heated	The screen may go blank if the internal temperature exceeds 50°C. If a consistent problem, suggest moving the unit to a cooler location
Fuse blows constantly	Short circuit in a solenoid valve or the wiring to it	Check the solenoid valve wiring and the solenoid valves for a short circuit.
Watering programs start at unscheduled times.	Watering programs have overlapping start times.	Reduce station times. Change/remove program start times.
A station does not turn on.	Faulty wiring at station module.	Check valve wiring and connections
Program starts again after completion of a watering cycle.	Watering programs have overlapped.	Reduce station times. Change/remove program start times.
	Water budget setting may be greater than 100%.	Review water budget setting.

APPENDIX A - GUIDELINES FOR WATERING

When deciding how much to water a garden or lawn, there are several factors to be considered:





- Soil type – clay, sand, silt, or a mixture of them
- Slope of the ground – does the water run off
- Type of grass or plants – the water needs of plants vary greatly
- Exposure to sun and shade – how much sun and at what time of day
- The rate at which water is applied – determined by the water pressure and the type of watering nozzle used
- Time of day that watering takes place – the best time to water is one to two hours before sunrise

It is therefore difficult to devise the perfect watering schedule and some trial and error will be required before you settle on the best schedule.





Here are some general watering hints to help you get started:

- Water early in the morning, one to two hours before sunrise, when the water pressure is highest and evaporation is lowest and the water can soak into the plant root zone. Watering during generally mid-day or in the evening may cause plant damage.
- Newly planted lawns, until established, should be watered frequently for short durations to keep the soil and plants moist at all times
- Reduce watering duration and water more frequently if water run off is occurring.
- Water an established landscape enough to saturate the soil without causing runoff.
- When starting a new watering program, gradually decrease watering over a period of time until you begin to notice signs of plant stress caused by lack of water, then increase watering a little to regain plant health and vitality. This method enables a healthy landscape to be maintained using the least amount of water.





APPENDIX B - WATERING SCHEDULE PLANNERS

VALVE NUMBER													
1							7						
2							8						
3							9						
4							10						
5							11						
6													
PROGRAM							PROGRAM						
	START TIME	WATERING DAYS	STATION	RUN TIME (minutes)	START TIME	WATERING DAYS		STATION	RUN TIME (minutes)				
1	Start Time 1:		1		4	Start Time 1:		1					
			2					2					
			3					3					
	Start Time 2: Start Time 3: Start Time 4: Start Time 5: Start Time 6:		4			4							
			5			5							
			6			6							
			7			7							
			8			8							
			9			9							
			10			10							
			11			11							
2	Start Time 1:		1		5	Start Time 1:		1					
			2					2					
			3					3					
	Start Time 2: Start Time 3: Start Time 4: Start Time 5: Start Time 6:		4			4							
			5			5							
			6			6							
			7			7							
			8			8							
			9			9							
			10			10							
			11			11							
3	Start Time 1:		1		6	Start Time 1:		1					
			2					2					
			3					3					
	Start Time 2: Start Time 3: Start Time 4: Start Time 5: Start Time 6:		4			4							
			5			5							
			6			6							
			7			7							
			8			8							
			9			9							
			10			10							
			11			11							





APPENDIX B - WATERING SCHEDULE PLANNERS

VALVE NUMBER													
1							7						
2							8						
3							9						
4							10						
5							11						
6													
PROGRAM							PROGRAM						
	START TIME	WATERING DAYS	STATION	RUN TIME (minutes)	START TIME	WATERING DAYS		STATION	RUN TIME (minutes)				
1	Start Time 1:		1		4	Start Time 1:		1					
			2					2					
			3					3					
	Start Time 2: Start Time 3: Start Time 4: Start Time 5: Start Time 6:		4			4							
			5			5							
			6			6							
			7			7							
			8			8							
			9			9							
			10			10							
			11			11							
2	Start Time 1:		1		5	Start Time 1:		1					
			2					2					
			3					3					
	Start Time 2: Start Time 3: Start Time 4: Start Time 5: Start Time 6:		4			4							
			5			5							
			6			6							
			7			7							
			8			8							
			9			9							
			10			10							
			11			11							
3	Start Time 1:		1		6	Start Time 1:		1					
			2					2					
			3					3					
	Start Time 2: Start Time 3: Start Time 4: Start Time 5: Start Time 6:		4			4							
			5			5							
			6			6							
			7			7							
			8			8							
			9			9							
			10			10							
			11			11							

APPENDIX B - WATERING SCHEDULE PLANNERS

VALVE NUMBER														
1							7							
2							8							
3							9							
4							10							
5							11							
6														
PROGRAM							PROGRAM							
	START TIME	WATERING DAYS	STATION	RUN TIME (minutes)	START TIME	WATERING DAYS		STATION	RUN TIME (minutes)					
1	Start Time 1:		1		4	Start Time 1:		1						
			2					2						
			3					3						
	Start Time 2: Start Time 3: Start Time 4: Start Time 5: Start Time 6:		4			Start Time 2: Start Time 3: Start Time 4: Start Time 5: Start Time 6:		4		Start Time 2: Start Time 3: Start Time 4: Start Time 5: Start Time 6:	5	Start Time 2: Start Time 3: Start Time 4: Start Time 5: Start Time 6:	5	Start Time 2: Start Time 3: Start Time 4: Start Time 5: Start Time 6:
			6					6						
			7					7						
			8					8						
			9					9						
			10					10						
			11					11						
			11					11						
2	Start Time 1:		1		5	Start Time 1:		1						
			2					2						
			3					3						
	Start Time 2: Start Time 3: Start Time 4: Start Time 5: Start Time 6:		4			Start Time 2: Start Time 3: Start Time 4: Start Time 5: Start Time 6:		4		Start Time 2: Start Time 3: Start Time 4: Start Time 5: Start Time 6:	5	Start Time 2: Start Time 3: Start Time 4: Start Time 5: Start Time 6:	5	Start Time 2: Start Time 3: Start Time 4: Start Time 5: Start Time 6:
			6					6						
			7					7						
			8					8						
			9					9						
			10					10						
			11					11						
			11					11						
3	Start Time 1:		1		6	Start Time 1:		1						
			2					2						
			3					3						
	Start Time 2: Start Time 3: Start Time 4: Start Time 5: Start Time 6:		4			Start Time 2: Start Time 3: Start Time 4: Start Time 5: Start Time 6:		4		Start Time 2: Start Time 3: Start Time 4: Start Time 5: Start Time 6:	5	Start Time 2: Start Time 3: Start Time 4: Start Time 5: Start Time 6:	5	Start Time 2: Start Time 3: Start Time 4: Start Time 5: Start Time 6:
			6					6						
			7					7						
			8					8						
			9					9						
			10					10						
			11					11						
			11					11						

APPENDIX B - WATERING SCHEDULE PLANNERS

VALVE NUMBER													
1							7						
2							8						
3							9						
4							10						
5							11						
6													
PROGRAM							PROGRAM						
	START TIME	WATERING DAYS	STATION	RUN TIME (minutes)	START TIME	WATERING DAYS		STATION	RUN TIME (minutes)	START TIME	WATERING DAYS	STATION	RUN TIME (minutes)
1	Start Time 1:		1		4	Start Time 1:		1		Start Time 2: Start Time 3: Start Time 4: Start Time 5: Start Time 6:		1	
			2					2				2	
			3					3				3	
	4		4			4							
	5		5			5							
	6		6			6							
	7		7			7							
	8		8			8							
	9		9			9							
	10		10			10							
	11		11			11							
2	Start Time 1:		1		5	Start Time 1:		1		Start Time 2: Start Time 3: Start Time 4: Start Time 5: Start Time 6:		1	
			2					2				2	
			3					3				3	
	4		4			4							
	5		5			5							
	6		6			6							
	7		7			7							
	8		8			8							
	9		9			9							
	10		10			10							
	11		11			11							
3	Start Time 1:		1		6	Start Time 1:		1		Start Time 2: Start Time 3: Start Time 4: Start Time 5: Start Time 6:		1	
			2					2				2	
			3					3				3	
	4		4			4							
	5		5			5							
	6		6			6							
	7		7			7							
	8		8			8							
	9		9			9							
	10		10			10							
	11		11			11							